

# WGM600HD120T1

1200V, 600A dual IGBT module with Trench Field Stop technology

## Features:

- Trench-FS IGBT
- Low  $V_{CE\ set}$
- Low Switching Loss
- Low  $L_s$
- $T_j\ max=175\ ^\circ C$
- 100%RBSOA Tested (2Ic)
- $V_{CE\ set}$  with positive temp. coefficient
- RoHS



## Applications:

- Motor Drives
- Servo Drives
- UPS
- Welding

## Maximum Rated Valued of IGBT

集电极-发射极电压 Collector-emitter voltage	$V_{CES}$	$T_J=25^\circ C$	1200	V
栅极-发射极峰值电压 Gate-emitter peak voltage	$V_{GES}$		$\pm 20$	V
连续集电极电流 Continuous collector current	$I_C$	$T_C=100^\circ C$ $T_C=25^\circ C$	600 1160	A
集电极重复峰值电流 Repetitive peak collector current	$I_{CM}$	$T_J=175^\circ C, t_p=1ms$	1200	A
最大损耗功率 Maximum power dissipation per IGBT	$P_D$	$T_C=25^\circ C$ $T_J\ max=175^\circ C$	3950	W



## Electrical Characteristics of IGBT

			Min.	Typ.	Max.		
集电极-发射极饱和电压 Collector-emitter saturation voltage	$V_{CE\ sat}$	$I_C=600A, V_{GE}=15V$	$T_J=25^\circ C$ $T_J=125^\circ C$ $T_J=150^\circ C$	1.7 1.9 2.0	1.95		V V V
栅极阈值电压 Gate threshold voltage	$V_{GE(th)}$	$I_C=10mA, V_{CE}=V_{GE}$	$T_J=25^\circ C$	5.0	5.5	6.8	V
栅极电荷 Gate charge	$Q_G$	$V_{GE} = -15 V \dots +15 V$	$T_J=25^\circ C$		3.36		$\mu C$
内部栅极电阻 Internal gate resistor	$R_{Gint}$		$T_J=25^\circ C$		1.1		$\Omega$
输入电容 Input capacitance	$C_{ies}$	$f=1MHz, V_{CE}=25V, V_{GE}=0V$	$T_J=25^\circ C$		49.26		nF
反向传输电容 Reverse transfer capacitance	$C_{res}$	$f=1MHz, V_{CE}=25V, V_{GE}=0V$	$T_J=25^\circ C$		3.67		nF
集电极-发射极截止电流 Collector-emitter cut-off current	$I_{CES}$	$V_{CE}=1200V, V_{GE}=0V$	$T_J=25^\circ C$			1	mA
栅极-发射极漏电流 Gate-emitter leakage current	$I_{GES}$	$V_{CE}=0V, V_{GE}=\pm 20V$	$T_J=25^\circ C$			800	nA
开通延迟时间 (电感负载) Turn-on delay time	$t_{d\ on}$	$V_{CC}=600V, I_C=600A, R_{Gon}=1\Omega,$ $V_{GE}=\pm 15V$	$T_J=25^\circ C$ $T_J=125^\circ C$ $T_J=150^\circ C$		0.55 0.56 0.56		$\mu s$ $\mu s$ $\mu s$
上升时间 (电感负载) Rise time	$t_r$	$V_{CC}=600V, I_C=600A, R_{Gon}=1\Omega,$ $V_{GE}=\pm 15V$	$T_J=25^\circ C$ $T_J=125^\circ C$ $T_J=150^\circ C$		0.22 0.22 0.23		$\mu s$ $\mu s$ $\mu s$
关断延迟时间 (电感负载) Turn-off delay time	$t_{d\ off}$	$V_{CC}=600V, I_C=600A, R_{Goff}=1\Omega,$ $V_{GE}=\pm 15V$	$T_J=25^\circ C$ $T_J=125^\circ C$ $T_J=150^\circ C$		0.54 0.57 0.57		$\mu s$ $\mu s$ $\mu s$
下降时间 (电感负载) Fall time	$t_f$	$V_{CC}=600V, I_C=600A, R_{Goff}=1\Omega,$ $V_{GE}=\pm 15V$	$T_J=25^\circ C$ $T_J=125^\circ C$ $T_J=150^\circ C$		0.14 0.18 0.19		$\mu s$ $\mu s$ $\mu s$
开通损耗能量 (电感负载) Turn-on energy loss per pulse	$E_{on}$	$V_{CC}=600V, I_C=600A, R_{Gon}=1\Omega,$ $V_{GE}=\pm 15V$ $di/dt=2120A/\mu s (T_J=150^\circ C)$	$T_J=25^\circ C$ $T_J=125^\circ C$ $T_J=150^\circ C$		49 75.8 81.2		mJ mJ mJ
关断损耗能量 (电感负载) Turn-off energy loss per pulse	$E_{off}$	$V_{CC}=600V, I_C=600A, R_{Goff}=1\Omega,$ $V_{GE}=\pm 15V$ $du/dt=2600V/\mu s (T_J=150^\circ C)$	$T_J=25^\circ C$ $T_J=125^\circ C$ $T_J=150^\circ C$		81.5 96.1 100.1		mJ mJ mJ
短路数据 SC data	$I_{SC}$	$V_{GE}=\pm 15V, V_{CC}=600V, R_G=1\Omega,$ $t_P=10\mu s$	$T_J=150^\circ C$		2500		A
结-外壳热阻 Thermal resistance, junction to case	$R_{th\ JC}$	per leg			0.038		K/W



## Maximum Rated Valued of Diode

反向重复峰值电压 Repetitive peak reverse voltage	$V_{RRM}$		$T_C=25^{\circ}\text{C}$	1200	V
正向连续电流 continuous forward current	$I_F$		$T_C=25^{\circ}\text{C}$	600	A
正向峰值电流 Maximum forward voltage	$I_{FM}$	$t_p=1\text{ms}$	$T_C=25^{\circ}\text{C}$	1200	A

## Electrical Characteristics of Diode

			Min.	Typ.	Max.	
正向电压 Forward voltage	$V_F$	$I_F=600\text{A}$	$T_J=25^{\circ}\text{C}$	1.8	2.0	V
			$T_J=125^{\circ}\text{C}$	1.9		V
			$T_J=150^{\circ}\text{C}$	1.9		V
反向恢复峰值电流 Peak reverse recovery current	$I_{RM}$	$V_R=600\text{V}, I_F=600\text{A}, V_{GE}=-15\text{V}$ $-di/dt=2270\text{A}/\mu\text{s} (T_J=150^{\circ}\text{C})$	$T_J=25^{\circ}\text{C}$	238		A
			$T_J=125^{\circ}\text{C}$	294		A
			$T_J=150^{\circ}\text{C}$	306		A
反向恢复时间 Reverse recovery time	$t_{rr}$	$V_R=600\text{V}, I_F=600\text{A}, V_{GE}=-15\text{V}$ $-di/dt=2270\text{A}/\mu\text{s} (T_J=150^{\circ}\text{C})$	$T_J=25^{\circ}\text{C}$	0.37		$\mu\text{s}$
			$T_J=125^{\circ}\text{C}$	0.58		$\mu\text{s}$
			$T_J=150^{\circ}\text{C}$	0.65		$\mu\text{s}$
反向恢复电荷 Reverse Recovery charge	$Q_r$	$V_R=600\text{V}, I_F=600\text{A}, V_{GE}=-15\text{V}$ $-di/dt=2270\text{A}/\mu\text{s} (T_J=150^{\circ}\text{C})$	$T_J=25^{\circ}\text{C}$	52.3		$\mu\text{C}$
			$T_J=125^{\circ}\text{C}$	96.1		$\mu\text{C}$
			$T_J=150^{\circ}\text{C}$	110.6		$\mu\text{C}$
反向恢复损耗 (每脉冲) Reverse recovery energy	$E_{rec}$	$V_R=600\text{V}, I_F=600\text{A}, V_{GE}=-15\text{V}$ $-di/dt=2270\text{A}/\mu\text{s} (T_J=150^{\circ}\text{C})$	$T_J=25^{\circ}\text{C}$	22		mJ
			$T_J=125^{\circ}\text{C}$	38.3		mJ
			$T_J=150^{\circ}\text{C}$	44.6		mJ
结-外壳热阻 Thermal resistance, junction to case	$R_{thJC}$	per leg		0.064		K/W

## NTC-Thermistor

额定电阻值 Rated resistance	$R_{25}$	$T_C=25^{\circ}\text{C}$	5		K $\Omega$
R100 偏差 Deviation of R100	$\Delta R/R$	$T_C=100^{\circ}\text{C}, R_{100}=481\Omega$		$\pm 5$	%
耗散功率 Power dissipation	$P_{25}$	$T_C=25^{\circ}\text{C}$	50		mW
B-值 B-Value	$B_{25/50}$	$R_2 = R_{25} \exp[B_{25/50} (1/T_2 - 1/(298.15\text{K}))]$	3380		K
B-值 B-Value	$B_{25/80}$	$R_2 = R_{25} \exp[B_{25/80} (1/T_2 - 1/(298.15\text{K}))]$	3440		K



Module			Min.	Typ.	Max.	
绝缘电压 Isolation voltage	V <sub>iso</sub>	f=50Hz, t=1min, RMS, All terminals shorted	2500			V
模块寄生电感 Stray Inductance Module	L <sub>s</sub>			20		nH
相对电痕指数 Comparative tracking index	CTI		200			V
最高结温 Maximum junction temperature	T <sub>J max</sub>		-40		175	°C
工作结温 Operating junction temperature	T <sub>J OP</sub>		-40		150	°C
储存温度 Storage temperature	T <sub>stg</sub>		-40		125	°C
外壳-散热器热阻 Thermal resistance, case to heatsink	R <sub>thCH</sub>	Thermal grease applied		0.020		K/W
安装扭矩 Mounting torque	T	Power terminals screw: M6 Mounting screw: M5	4.0 3.0		6.0 5.0	N·m N·m
重量 Weight	G			330		g



Fig.1 Typical saturation voltage characteristics vs temp.  
IGBT, Inverter

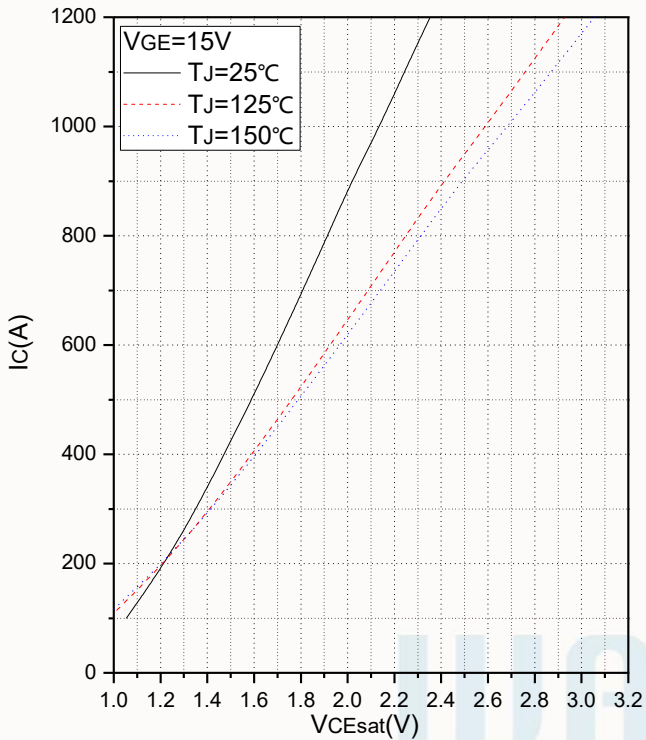

Fig.2 Typical output characteristics vs VGE  
IGBT, Inverter

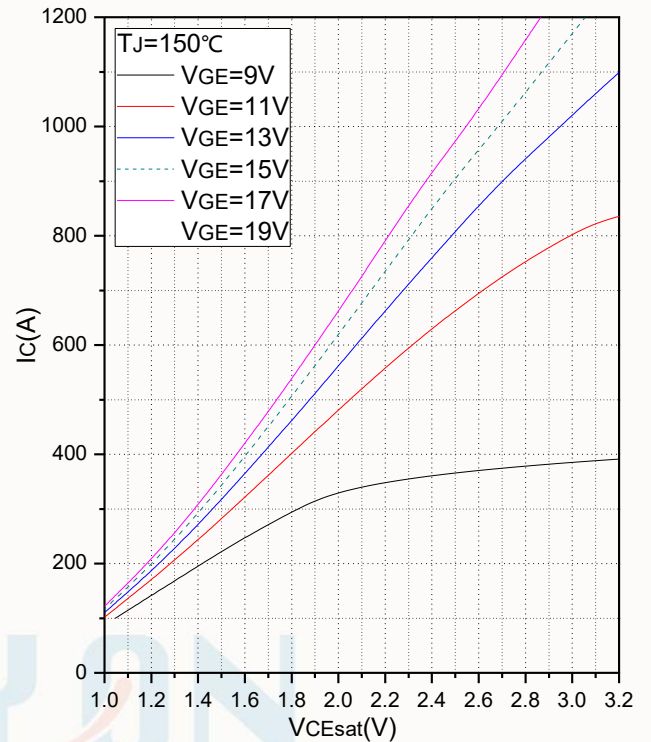

Fig.3 Transfer Characteristic  
IGBT, Inverter

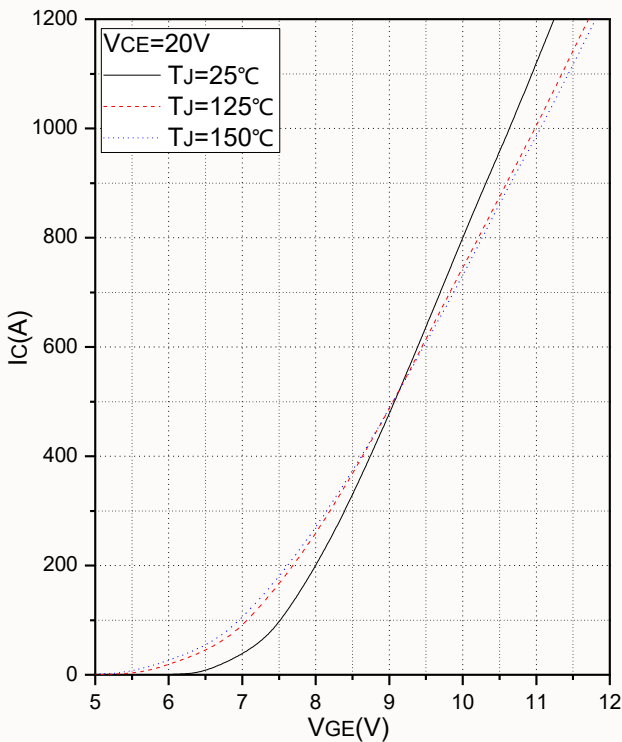

Fig.4 Typical switching loss vs Collector current  
IGBT, Inverter

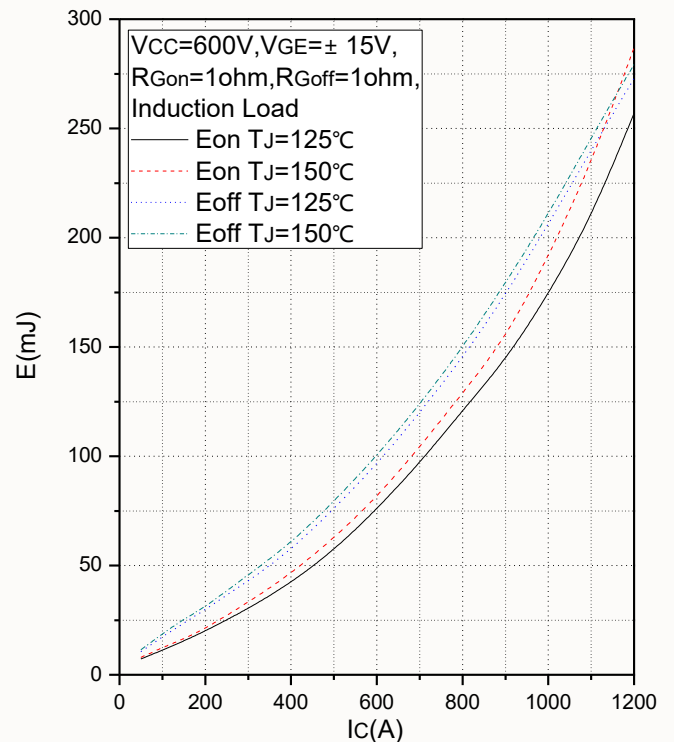

Fig.5 Typical switching loss vs Gate resistance  
IGBT, Inverter

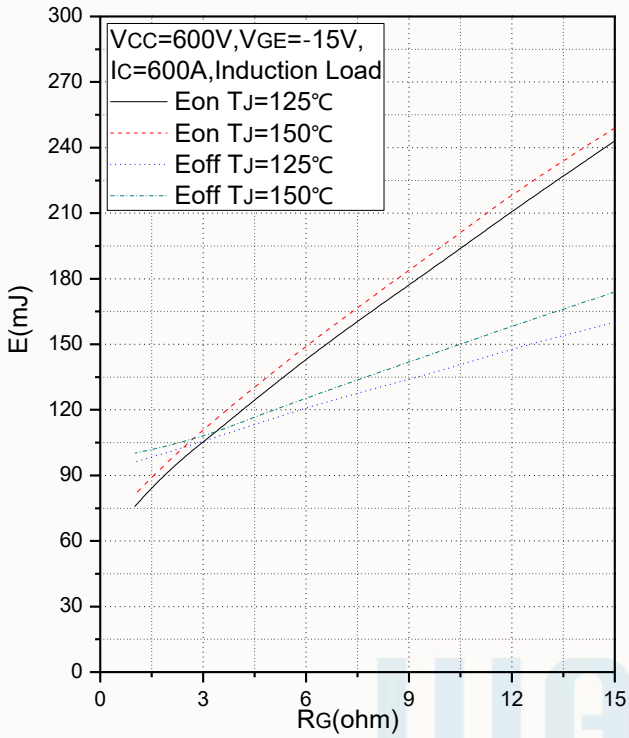

Fig.7 Typical forward characteristic  
Diode, Inverter

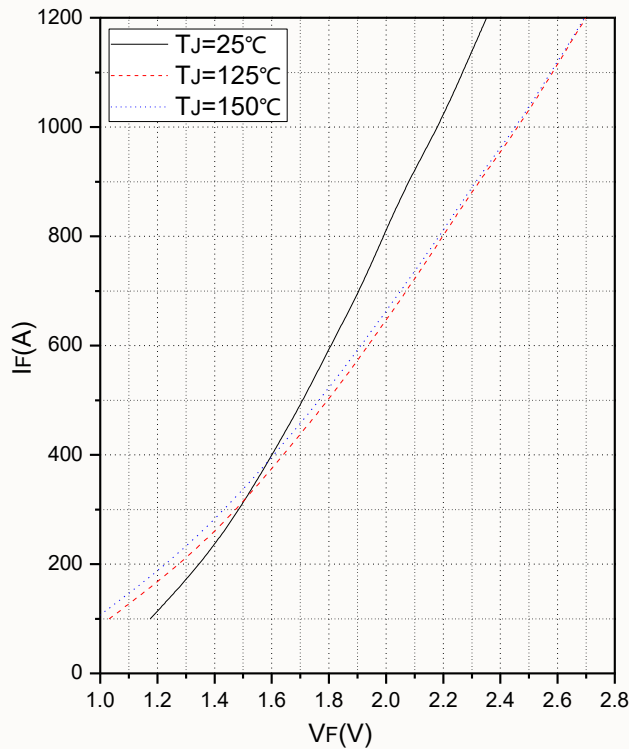

Fig.6 Transient thermal impedance  
IGBT, Inverter

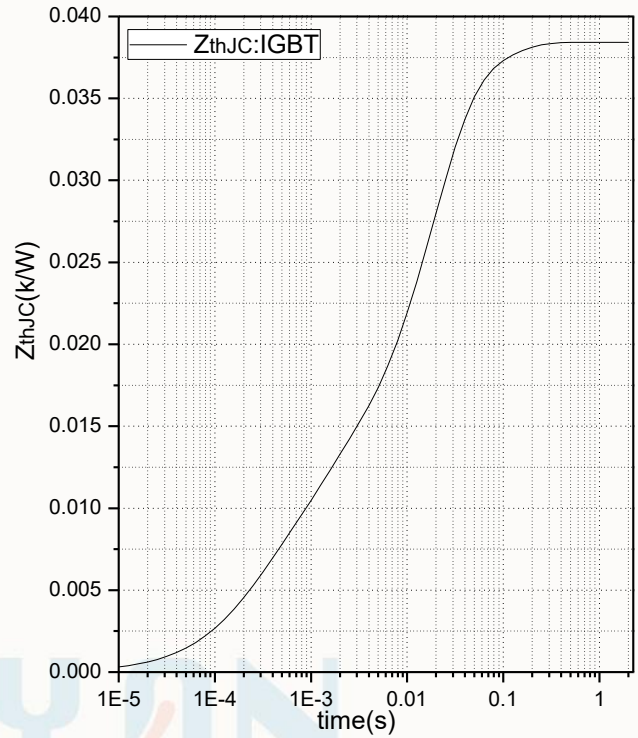

Fig.8 Typical switching loss vs Forward current  
Diode, Inverter

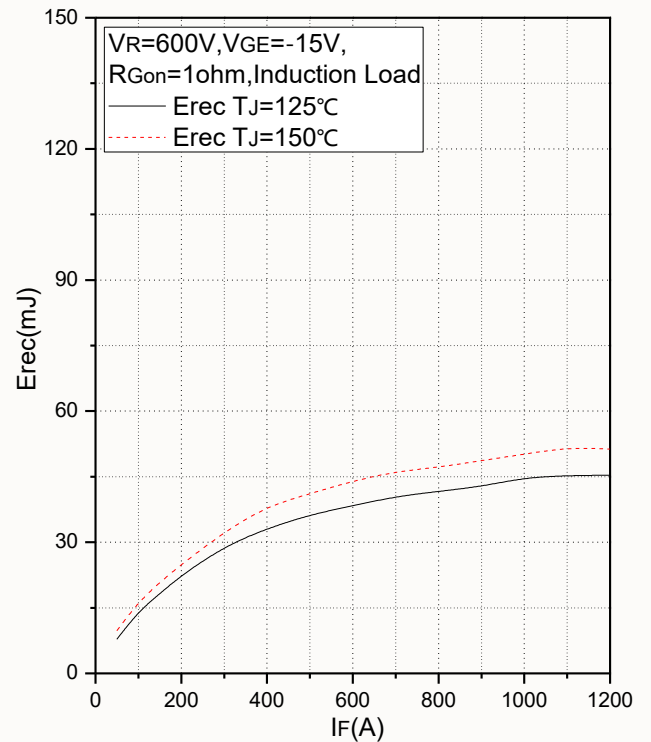

Fig.9 Typical switching loss vs Gate resistance  
Diode, Inverter

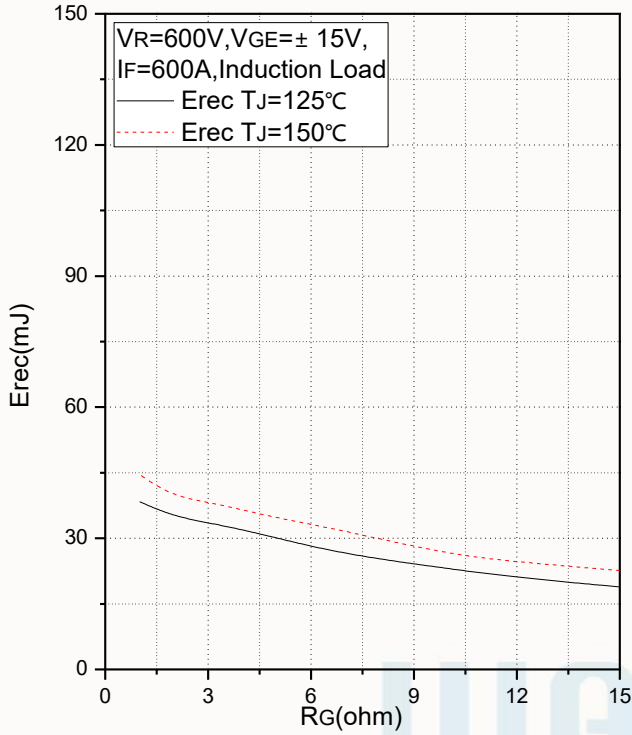

Fig.10 Transient thermal impedance  
Diode, Inverter

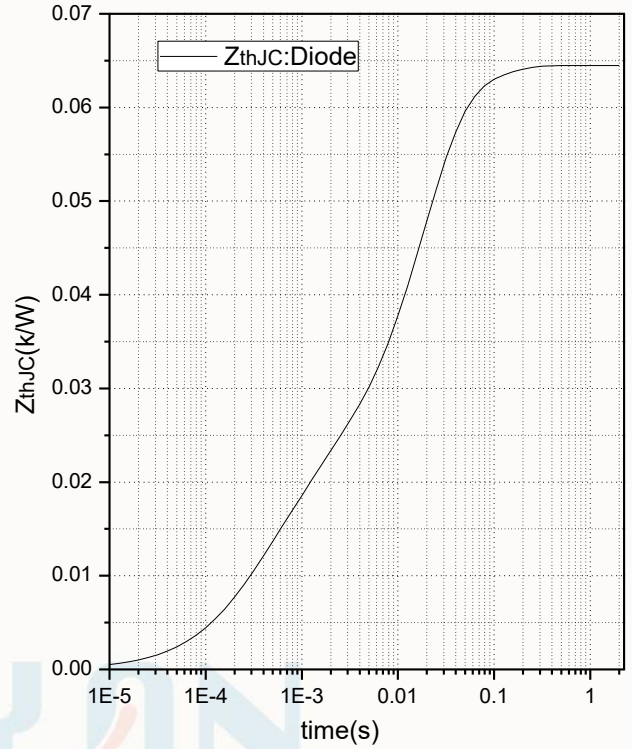

Fig.11 Reverse bias safe operating area (RBSOA)

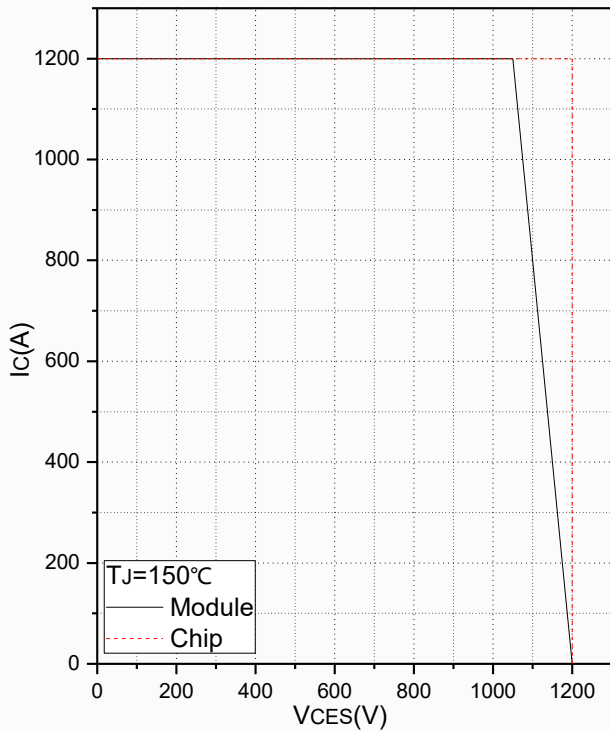

Fig.12 Capacitance Characteristics

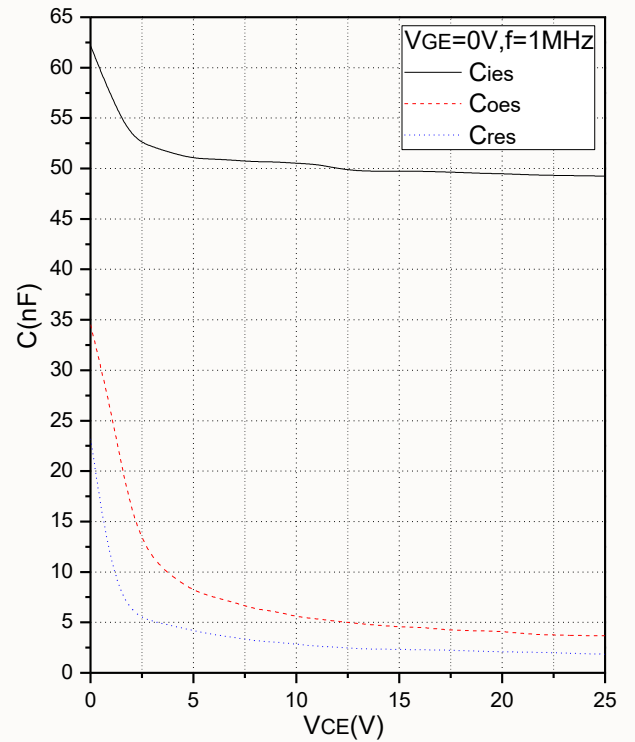

Fig.13 Typical Load Current vs. Frequency

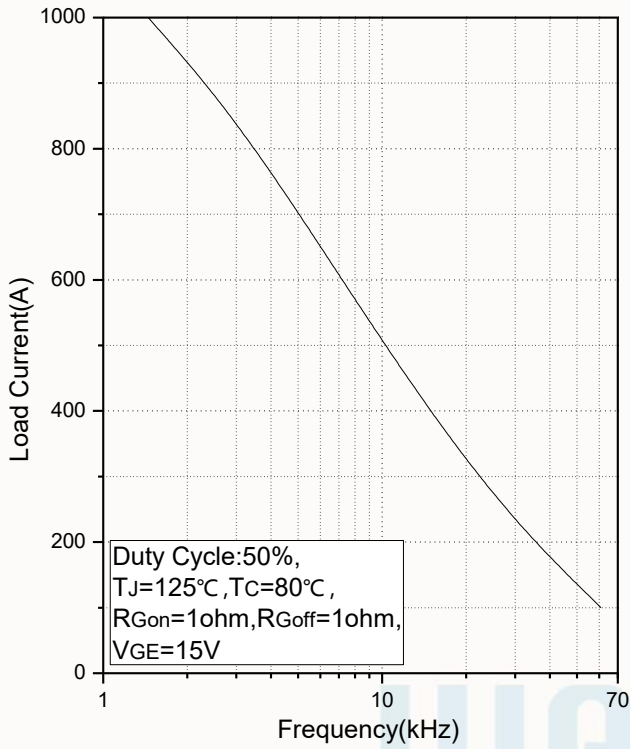

Fig.14 Rated Current vs. Temperature

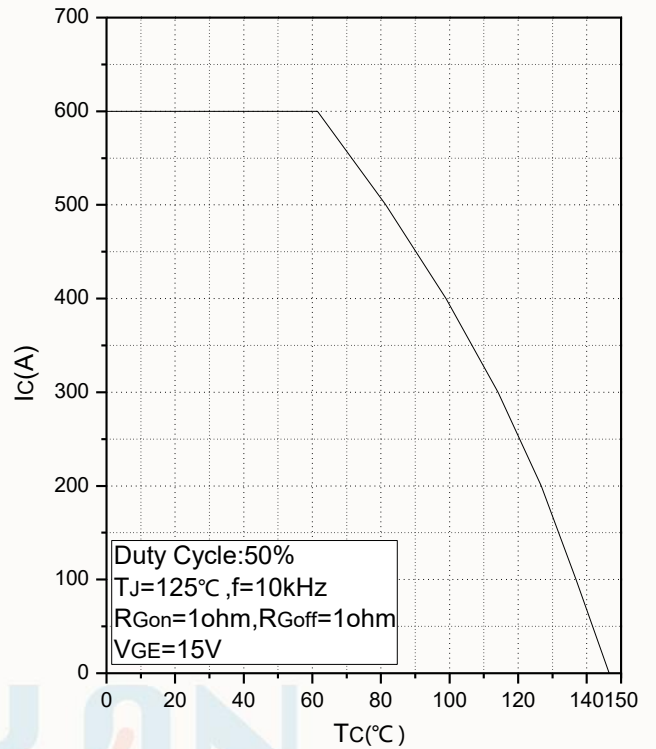
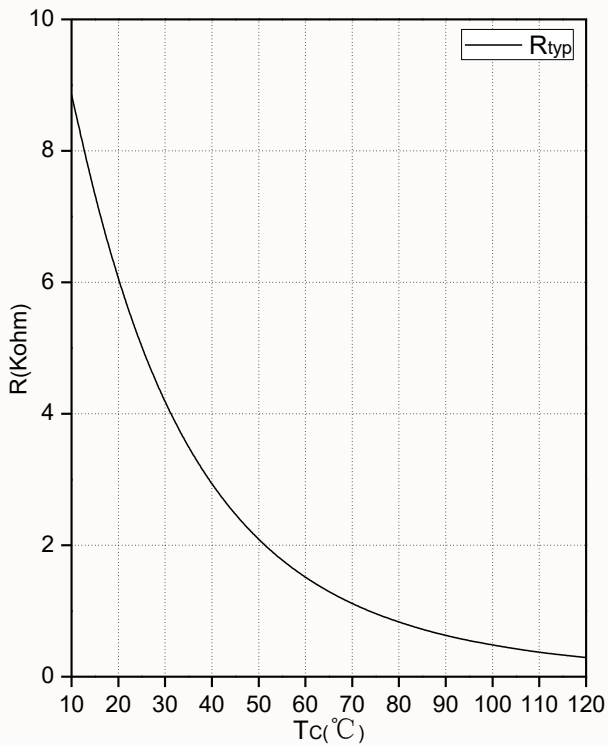
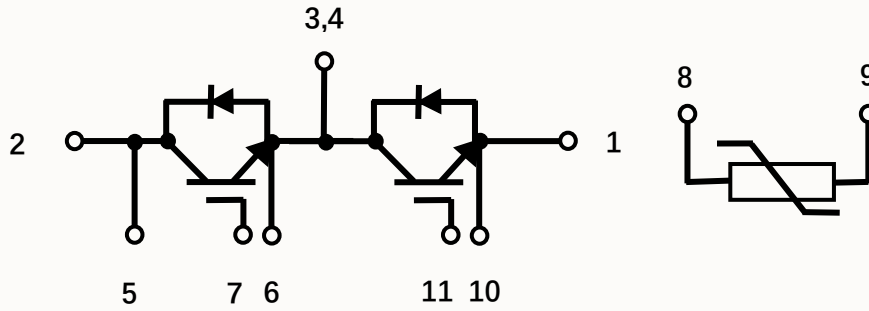

Fig.15 NTC Temperature Characteristics





Internal circuit (接线图)



Package outline (mm) (封装尺寸)

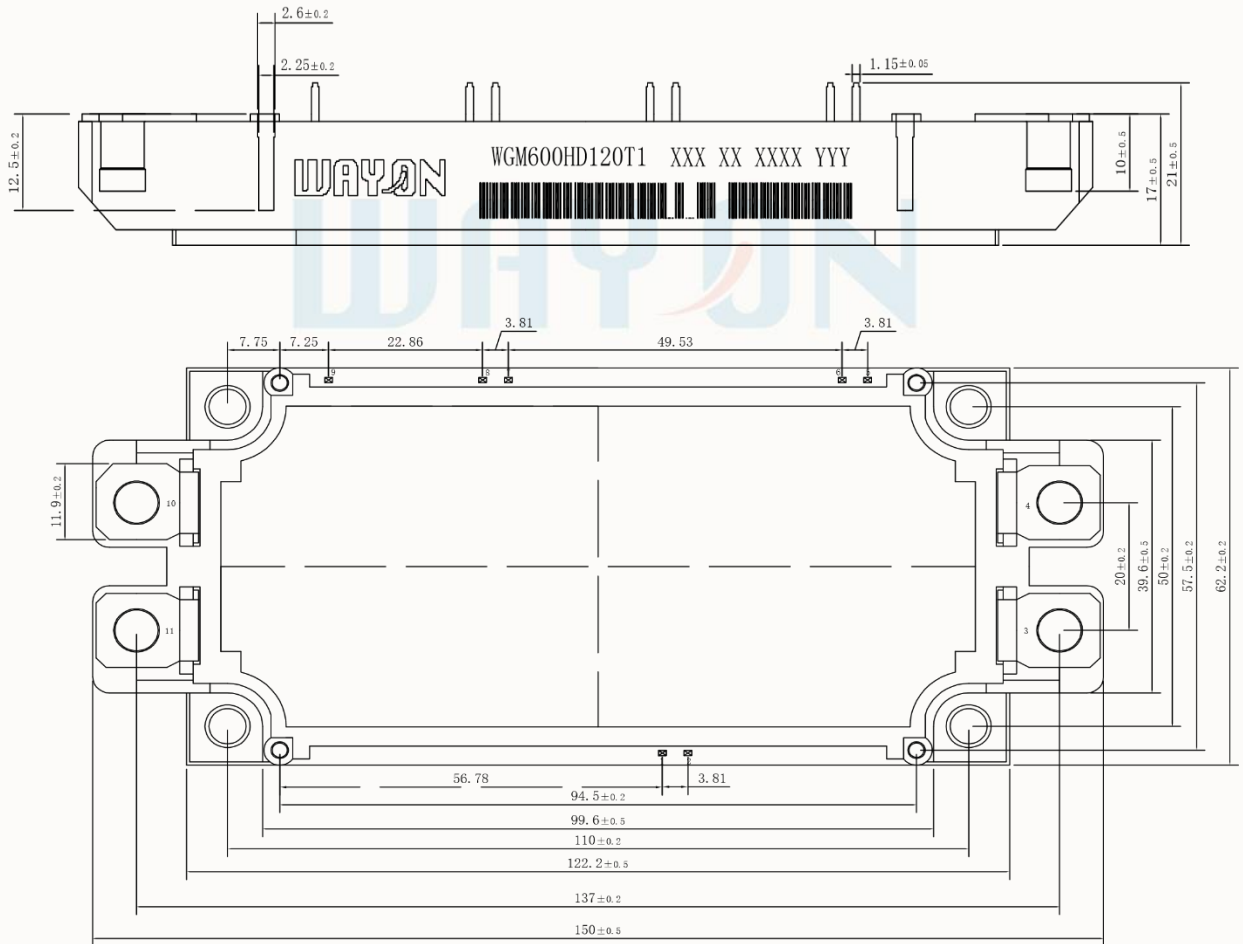

## Contact Information

No.1001, Shiwan(7) Road, Pudong District, Shanghai, P.R.China.201202

Tel: 86-21-50310888 Fax: 86-21-50757680 Email: market@way-on.com WAYON

website: <http://www.way-on.com>

For additional information, please contact your local Sales Representative.

 <sup>®</sup> is registered trademarks of Wayon Corporation.

## Disclaimer

WAYON reserves the right to make changes without further notice to any Products herein to improve reliability, function, or design. The Products are not designed for use in hostile environments, including, without limitation, aircraft, nuclear power generation, medical appliances, and devices or systems in which malfunction of any Product can reasonably be expected to result in a personal injury. The information given in this document shall in no event be regarded as a guarantee of conditions or characteristics. WAYON does not assume any liability for infringement of patents, copyrights, or other intellectual property rights of third parties by or arising from the use of Products or technical information described in this document.

