

### Features

- N-Channel  
40V/34A,  
 $R_{DS(ON)} = 12m\Omega$  (Typ.) @  $V_{GS} = 10V$   
 $R_{DS(ON)} = 18m\Omega$  (Typ.) @  $V_{GS} = 4.5V$
- P-Channel  
-40V/-23A,  
 $R_{DS(ON)} = 28m\Omega$  (Typ.) @  $V_{GS} = -10V$   
 $R_{DS(ON)} = 40m\Omega$  (Typ.) @  $V_{GS} = -4.5V$
- Very low on-resistance
- Fast Switching

### Applications

- Load Switch



### Pin Description

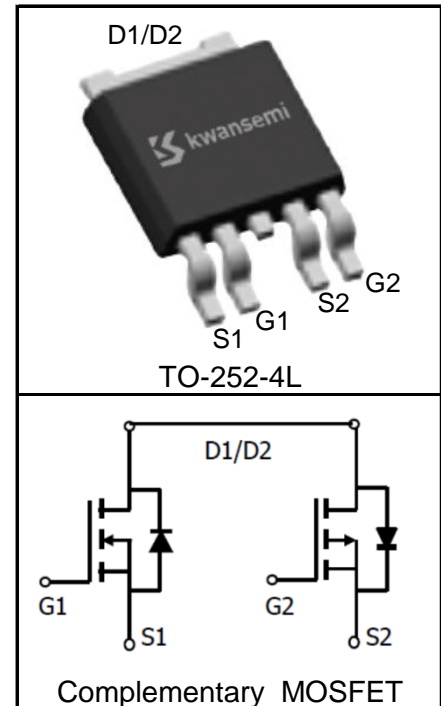

### Absolute Maximum Ratings

Symbol	Parameter	N-Channel	P-Channel	Unit	
<b>Common Ratings</b> ( $T_A = 25^\circ C$ Unless Otherwise Noted)					
$V_{DSS}$	Drain-Source Voltage	40	-40	V	
$V_{GSS}$	Gate-Source Voltage	$\pm 20$	$\pm 20$		
$T_J$	Maximum Junction Temperature	150	150	$^\circ C$	
$T_{STG}$	Storage Temperature Range	-55 to 150	-55 to 150	$^\circ C$	
$I_S$	Diode Continuous Forward Current	$T_C = 25^\circ C$	34	-23	A
<b>Mounted on Large Heat Sink</b>					
$I_{DP}^{①}$	300 $\mu s$ Pulse Drain Current Tested	$T_C = 25^\circ C$	60	-60	A
$I_D^{②}$	Continuous Drain Current ( $V_{GS} = \pm 10V$ )	$T_C = 25^\circ C$	34	-23	A
		$T_C = 100^\circ C$	21	-14	
$P_D$	Maximum Power Dissipation	$T_C = 25^\circ C$	31	31	W
		$T_C = 100^\circ C$	12	12	
$R_{\theta JC}$	Thermal Resistance-Junction to Case		4	4	$^\circ C/W$
$R_{\theta JA}^{③}$	Thermal Resistance-Junction to Ambient		100	100	$^\circ C/W$
<b>Drain-Source Avalanche Ratings</b>					
$E_{AS}^{④}$	Avalanche Energy, Single Pulsed		25	36	mJ

**Electrical Characteristics** ( $T_C=25^\circ\text{C}$  Unless Otherwise Noted)

Symbol	Parameter	Test Condition	KS4618DB4			Unit	
			Min.	Typ.	Max.		
<b>Static Characteristics</b>							
$BV_{DSS}$	Drain-Source Breakdown Voltage	$V_{GS}=0V, I_{DS}=250\mu A$	N	40		V	
		$V_{GS}=0V, I_{DS}=-250\mu A$	P	-40			
$I_{DSS}$	Zero Gate Voltage Drain Current	$V_{DS}=40V, V_{GS}=0V$	N		1	$\mu A$	
		$T_J=125^\circ C$			30		
		$V_{DS}=-40V, V_{GS}=0V$	P		-1		
		$T_J=125^\circ C$			-30		
$V_{GS(th)}$	Gate Threshold Voltage	$V_{DS}=V_{GS}, I_{DS}=250\mu A$	N	1.1	1.6	2.3	V
		$V_{DS}=V_{GS}, I_{DS}=-250\mu A$	P	-1.1	-1.6	-2.3	
$I_{GSS}$	Gate Leakage Current	$V_{GS}=\pm 20V, V_{DS}=0V$	N			$\pm 100$	nA
		$V_{GS}=\pm 20V, V_{DS}=0V$	P			$\pm 100$	
$R_{DS(ON)}^{(5)}$	Drain-Source On-state Resistance	$V_{GS}=10V, I_{DS}=12A$	N		12	18	m $\Omega$
		$V_{GS}=-10V, I_{DS}=-12A$	P		28	36	
		$V_{GS}=4.5V, I_{DS}=8A$	N		18	25	
		$V_{GS}=-4.5V, I_{DS}=-8A$	P		40	55	
<b>Diode Characteristics</b>							
$V_{SD}^{(5)}$	Diode Forward Voltage	$I_{SD}=12A, V_{GS}=0V$	N		0.85	1.2	V
		$I_{SD}=-12A, V_{GS}=0V$	P		-0.85	-1.2	
$t_{rr}$	Reverse Recovery Time	N-Channel $I_{SD}=12A, di_{SD}/dt=100A/\mu s$	N		8.5		ns
			P		17		
$Q_{rr}$	Reverse Recovery Charge	P-Channel $I_{SD}=-12A, di_{SD}/dt=100A/\mu s$	N		8		nC
			P		7		
<b>Dynamic Characteristics<sup>(6)</sup></b>							
$R_G$	Gate Resistance	$V_{GS}=0V, V_{DS}=0V, F=1MHz$	N		3.3		$\Omega$
			P		9.5		
$C_{iss}$	Input Capacitance	N-Channel $V_{GS}=0V, V_{DS}=20V,$ Frequency=1.0MHz	N		1290		pF
			P		1310		
$C_{oss}$	Output Capacitance	P-Channel $V_{GS}=0V, V_{DS}=-20V,$ Frequency=1.0MHz	N		100		
			P		115		
$C_{rss}$	Reverse Transfer Capacitance	N-Channel Frequency=1.0MHz	N		85		
			P		90		

**Electrical Characteristics** ( $T_C=25^\circ\text{C}$  Unless Otherwise Noted)

Symbol	Parameter	Test Condition	KS4618DB4			Unit	
			Min.	Typ.	Max.		
<b>Dynamic Characteristics</b> <sup>⑥</sup>							
$t_{d(ON)}$	Turn-on Delay Time	N-Channel $V_{DD}=20\text{V}$ , $I_{DS}=12\text{A}$ , $V_{GEN}=10\text{V}$ , $R_G=3\Omega$  P-Channel $V_{DD}=-20\text{V}$ , $I_{DS}=-12\text{A}$ , $V_{GEN}=-10\text{V}$ , $R_G=3\Omega$	N		7.5		ns
			P		9		
$t_r$	Turn-on Rise Time		N		4.8		
			P		7		
$t_{d(OFF)}$	Turn-off Delay Time		N		24		
			P		39		
$t_f$	Turn-off Fall Time		N		5.5		
			P		11		
<b>Gate Charge Characteristics</b> <sup>⑥</sup>							
$Q_g$	Total Gate Charge	N-Channel $V_{DS}=20\text{V}$ , $V_{GS}=10\text{V}$ , $I_{DS}=12\text{A}$  P-Channel $V_{DS}=-20\text{V}$ , $V_{GS}=-10\text{V}$ , $I_{DS}=-12\text{A}$	N		18		nC
			P		25		
$Q_{gs}$	Gate-Source Charge		N		3.5		
			P		4		
$Q_{gd}$	Gate-Drain Charge		N		4.2		
			P		6		

- Notes:
- ① Pulse width limited by safe operating area.
  - ② Calculated continuous current based on maximum allowable junction temperature.
  - ③ When mounted on 1 inch square copper board,  $t \leq 10\text{sec}$ . The value in any given application depends on the user's specific board design.
  - ④ Limited by  $T_{Jmax}$ . Starting  $T_J = 25^\circ\text{C}$ , N Channel:  $L = 0.5\text{mH}$ ,  $R_G = 25\Omega$ ,  $I_{AS} = 10\text{A}$ ,  $V_{GS} = 10\text{V}$ , P-Channel:  $L = 0.5\text{mH}$ ,  $R_G = 25\Omega$ ,  $I_{AS} = -12\text{A}$ ,  $V_{GS} = -10\text{V}$ , Part not recommended for use above this value.
  - ⑤ Pulse test; Pulse width  $\leq 300\mu\text{s}$ , duty cycle  $\leq 2\%$ .
  - ⑥ Guaranteed by design, not subject to production testing.

**Ordering and Marking Information**

Device	Package	Packaging	Quantity	Reel Size	Tape width
KS4618DB4	TO-252-4L	Tape&Reel	2500	13"	16mm

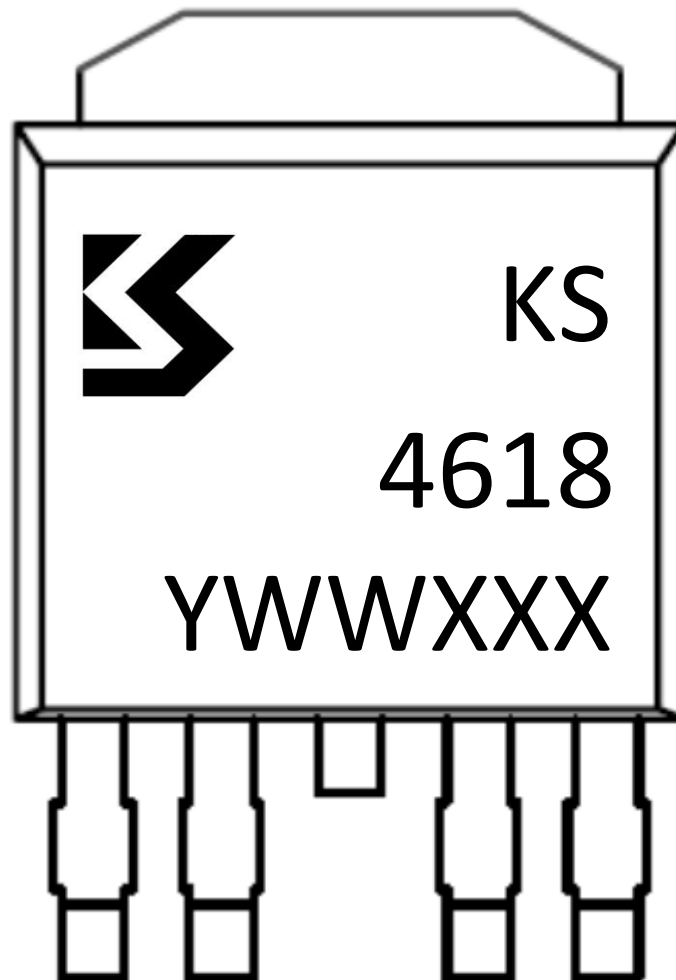

Y =Year,2017-A,2018-B,etc.

WW =Week.

XXX =Lot number.

### Typical Characteristics(N-Channel)

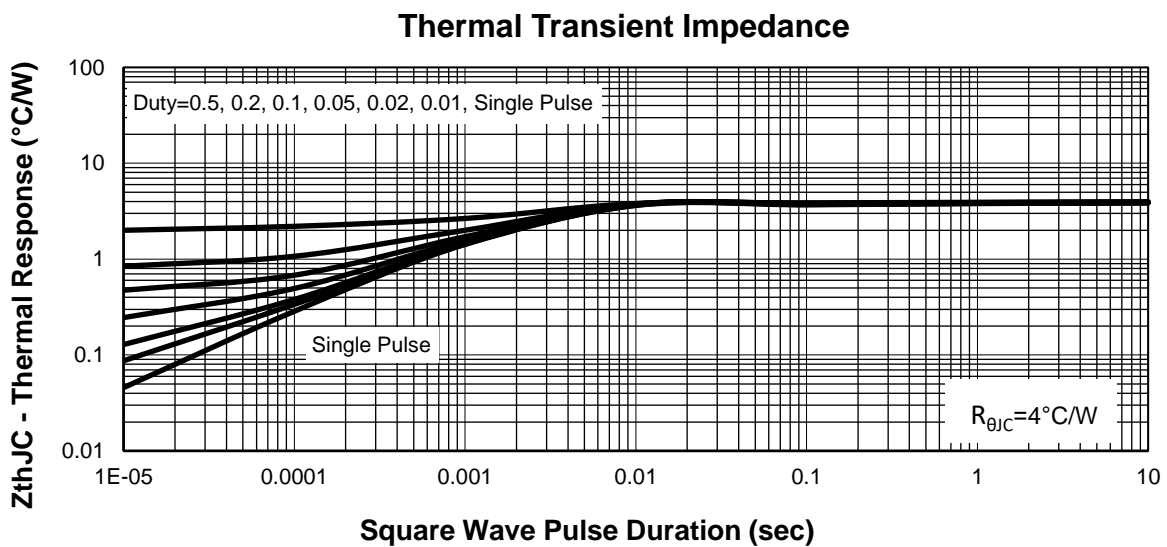
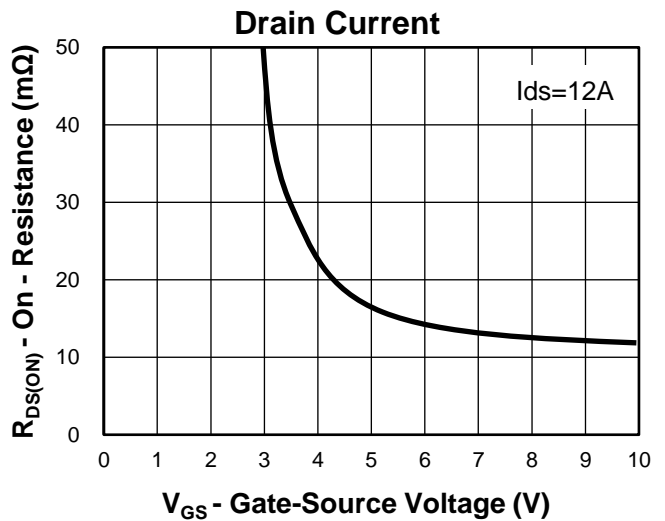
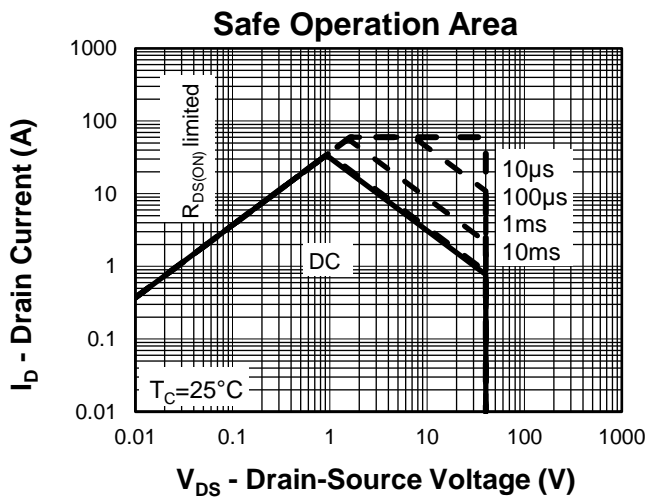
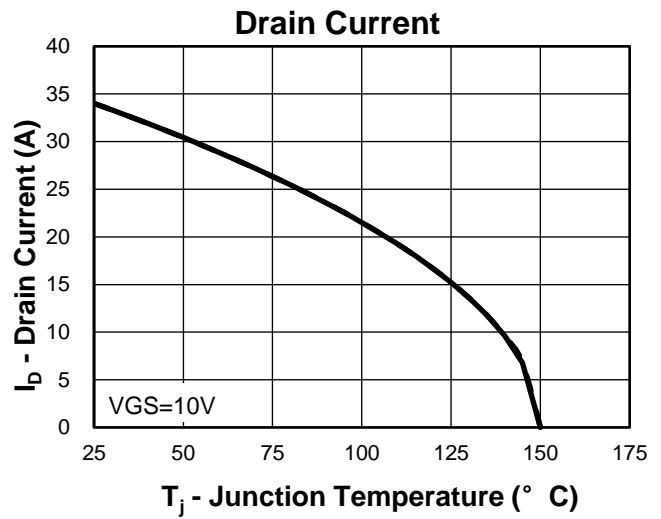
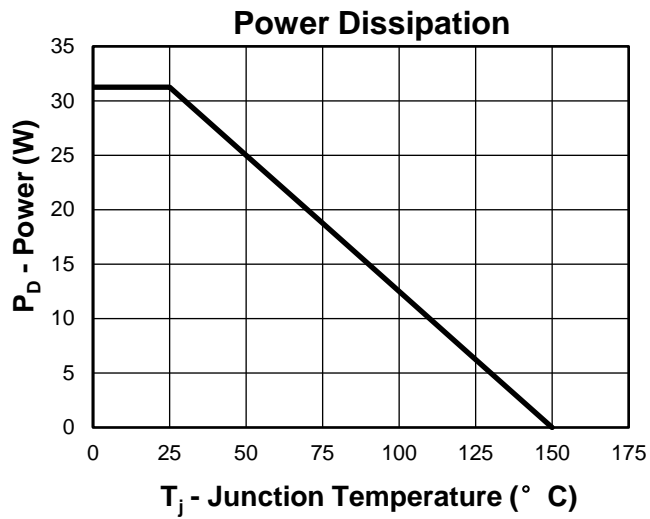

Typical Characteristics(N-Channel)

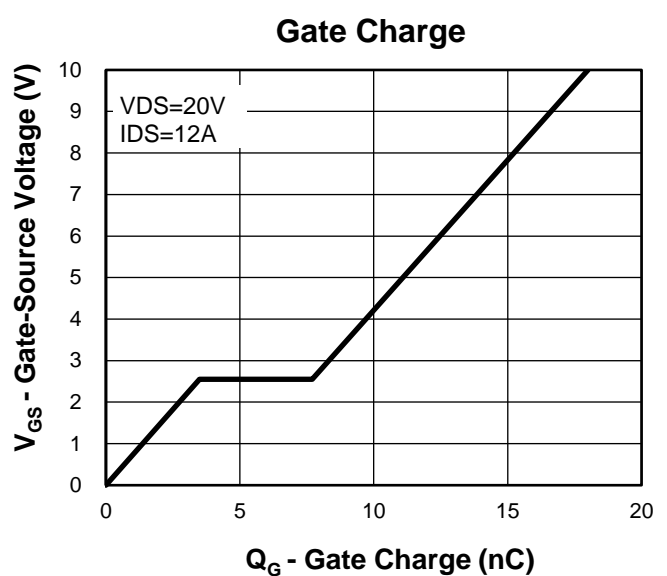
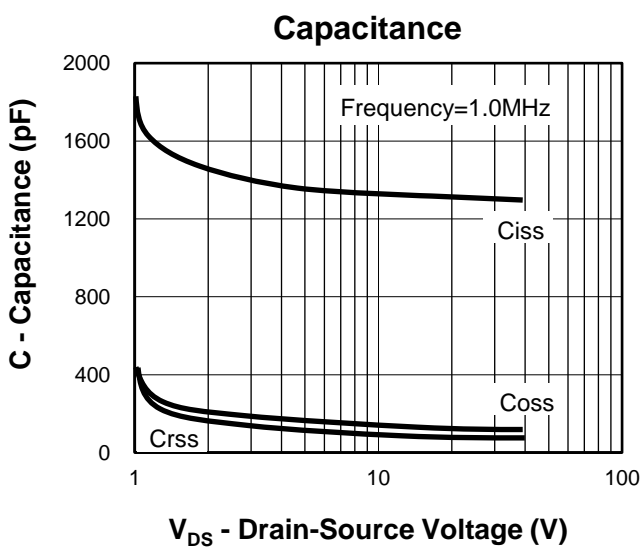
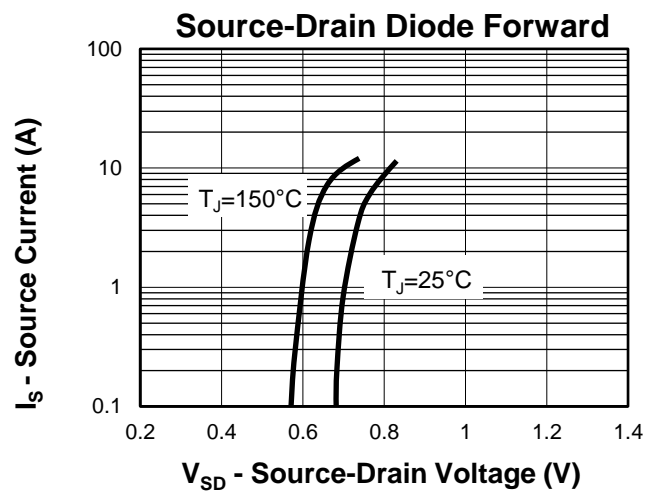
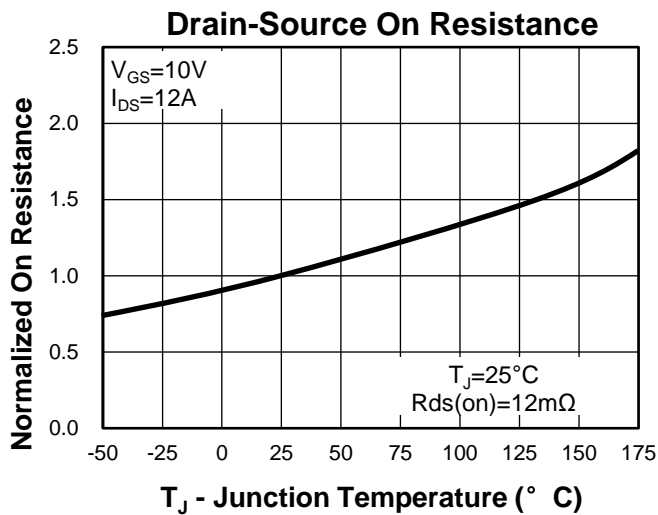
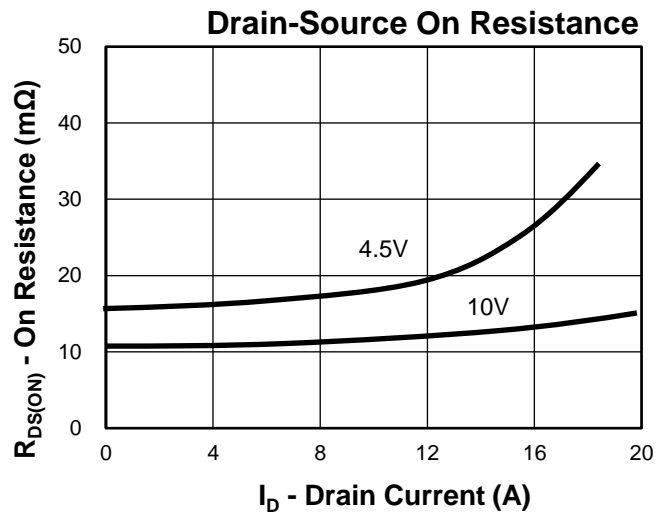
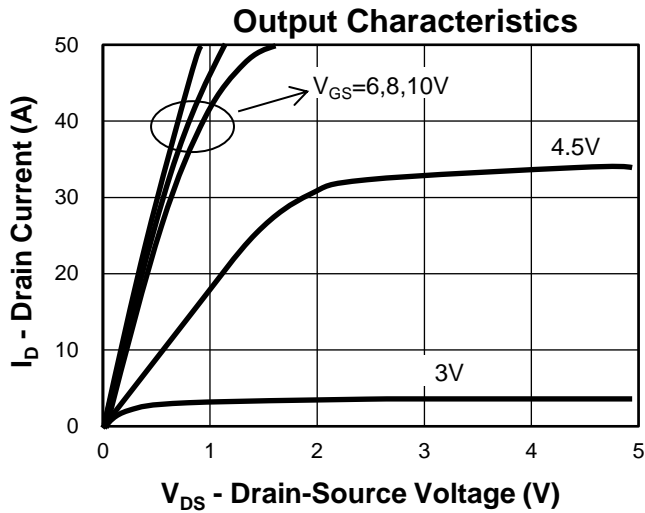

### Typical Characteristics(P-Channel)

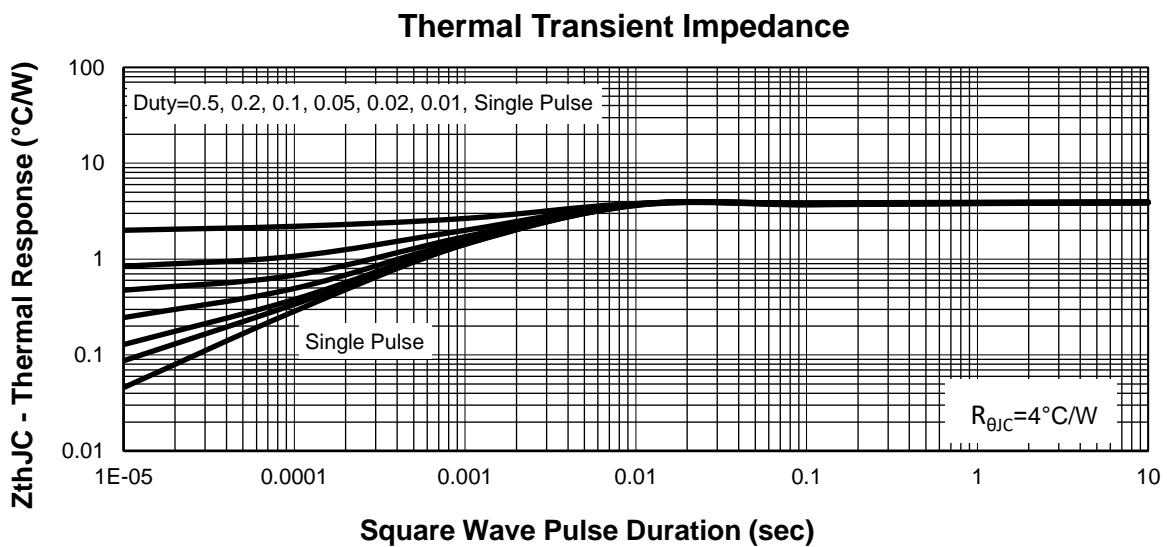
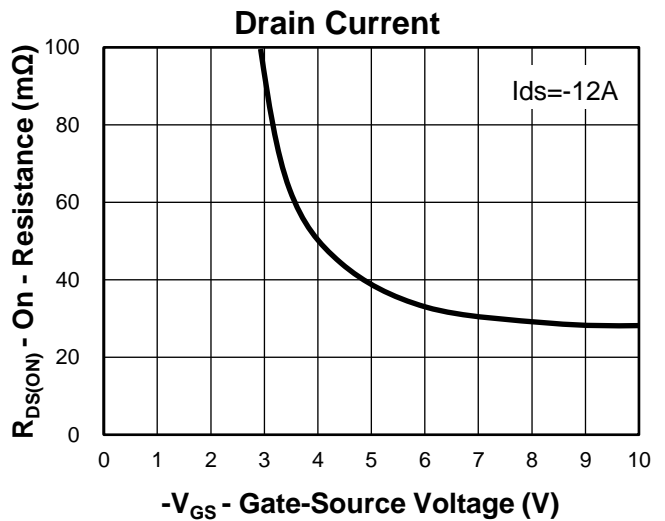
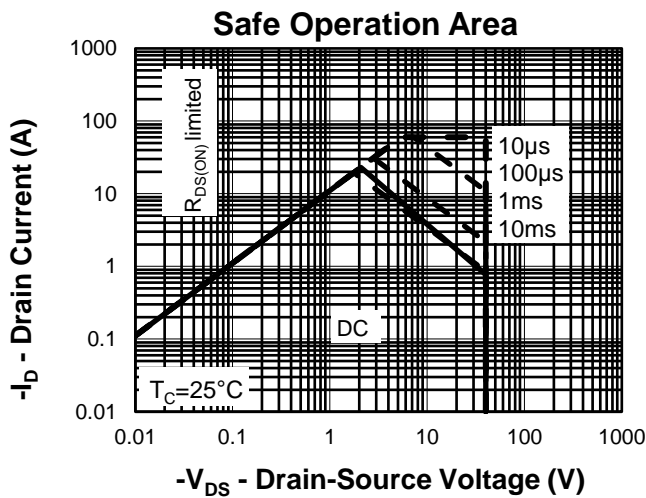
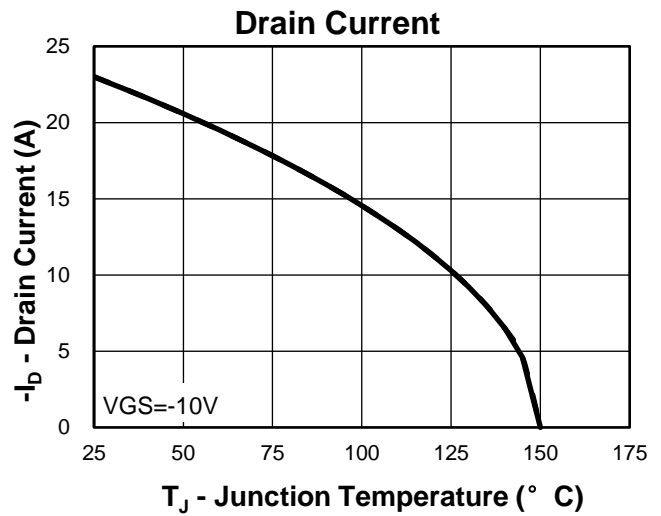
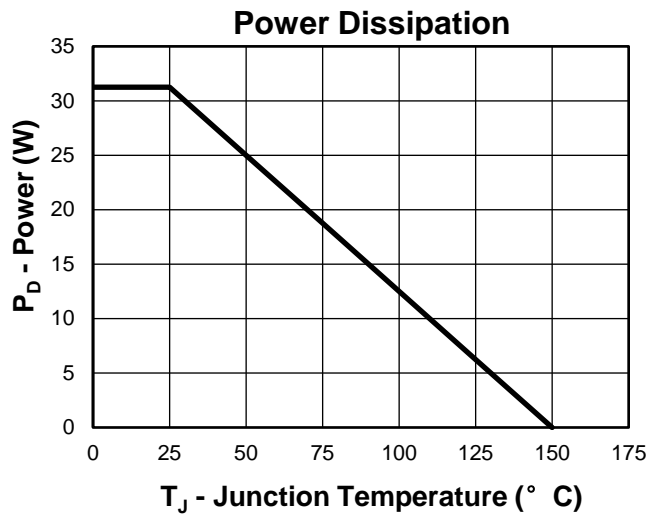

Typical Characteristics(P-Channel)

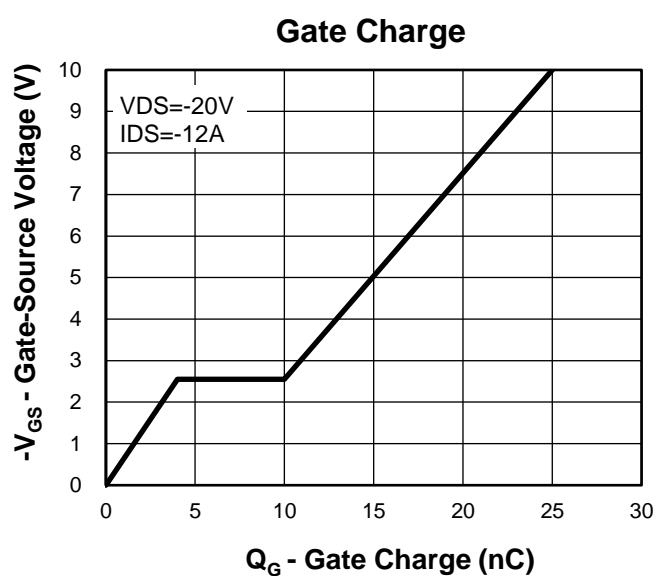
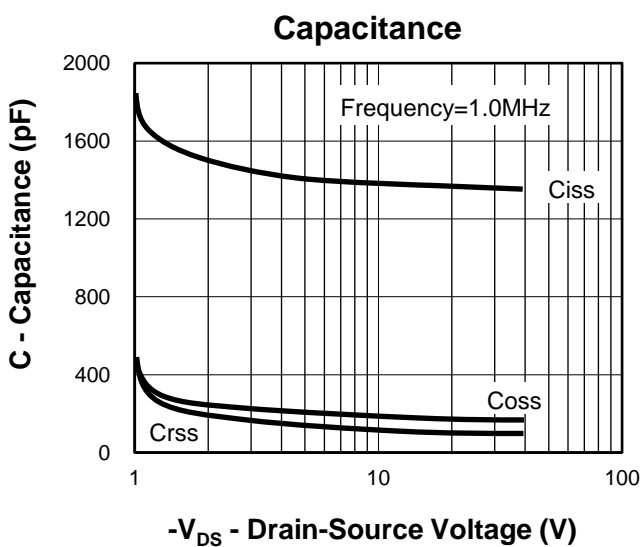
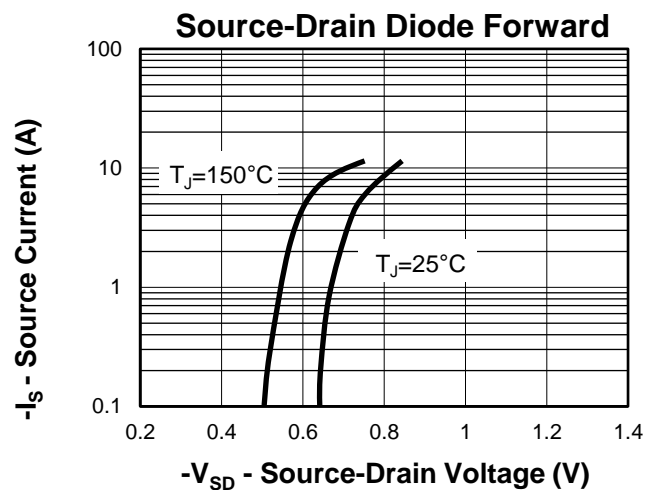
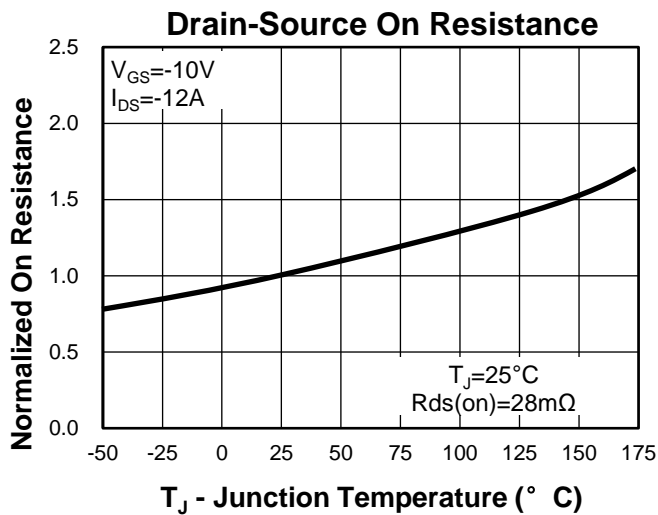
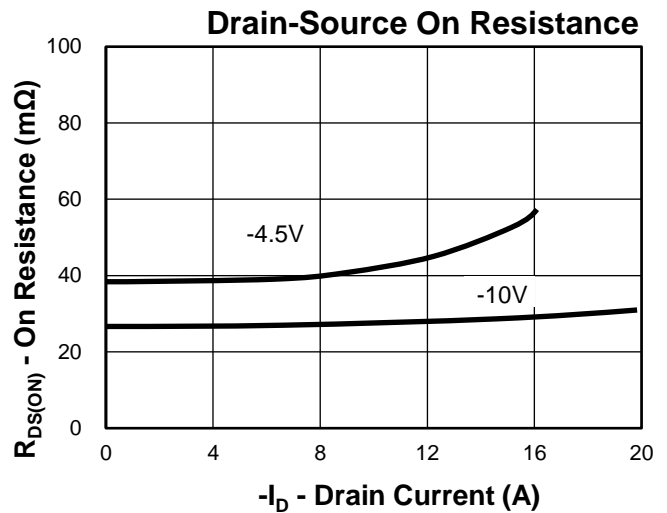
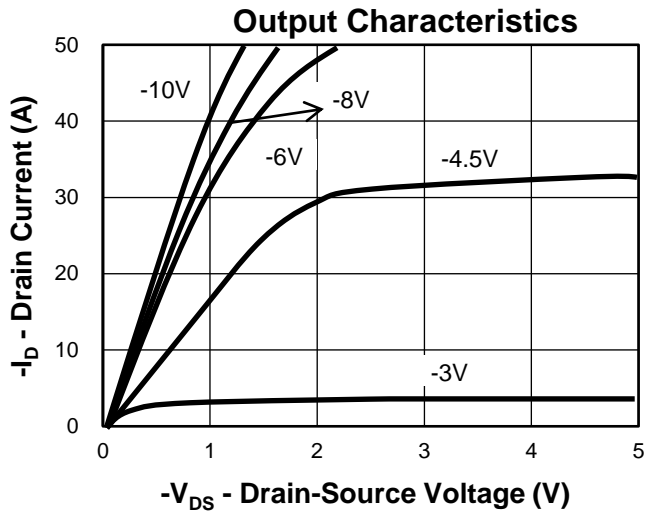

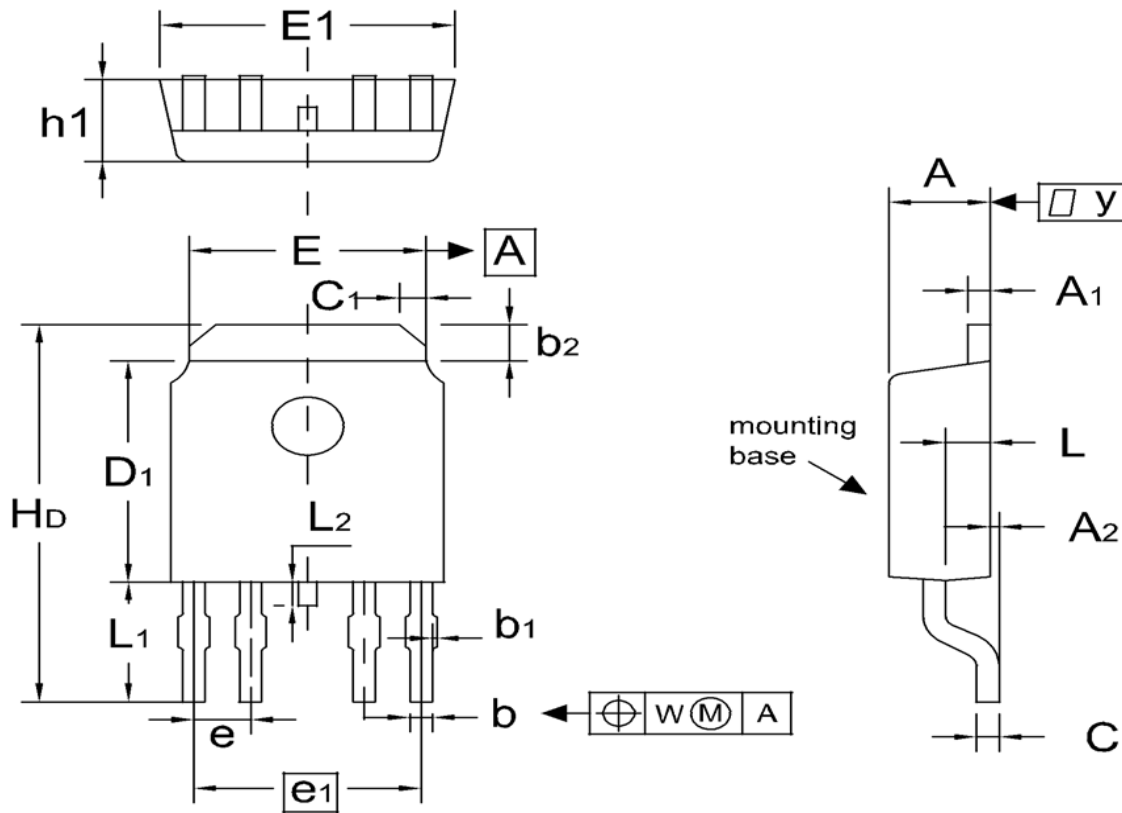

**Package Information**
**TO-252-4L**

SYMBOL	MM			INCH		
	MIN	NOM	MAX	MIN	NOM	MAX
A	2.190	2.285	2.380	0.086	0.090	0.094
A1	0.460	0.650	0.880	0.018	0.026	0.035
A2	--	--	0.127	--	--	0.005
b	0.510	0.610	0.710	0.020	0.024	0.028
b1	--	--	0.100	--	--	0.004
b2	0.890	1.080	1.270	0.035	0.043	0.050
C	0.460	0.530	0.600	0.018	0.021	0.024
C1	0.400	0.600	0.800	0.016	0.024	0.031
D1	5.970	6.095	6.220	0.235	0.240	0.245
E	4.320	4.890	5.460	0.170	0.193	0.215
E1	6.350	6.540	6.730	0.250	0.257	0.265
e		1.270 BSC			0.05 BSC	
e1		5.080 BSC			0.20 BSC	
H <sub>D</sub>	9.60	10.00	10.40	0.378	0.39	0.409
h1	2.19	2.29	2.38	0.086	0.09	0.094
L	0.80	1.00	1.20	0.031	0.04	0.047
L1	2.60	2.90	3.20	0.102	0.11	0.126
L2	0.350	0.650	0.950	0.014	0.026	0.037

**Avalanche Test Circuit and Waveforms(N-Channel)**

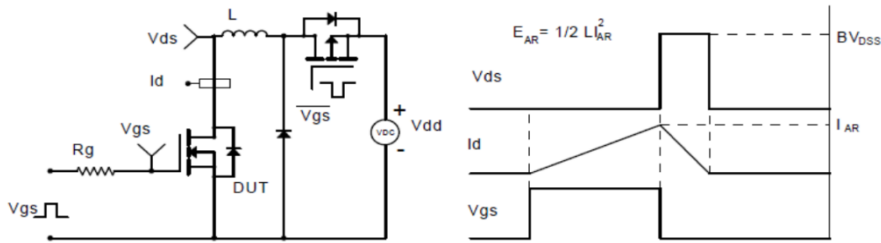

**Switching Time Test Circuit and Waveforms(N-Channel)**

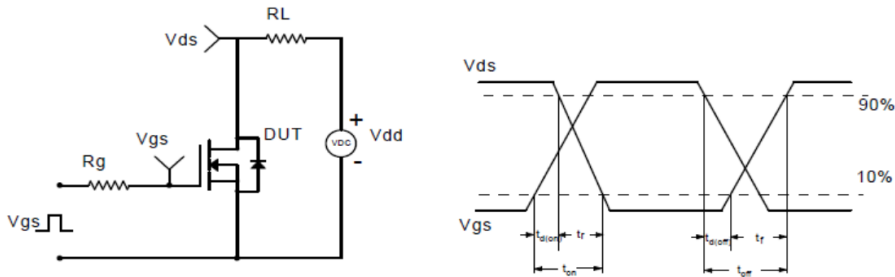

**Diode Recovery Test Circuit and Waveforms(N-Channel)**

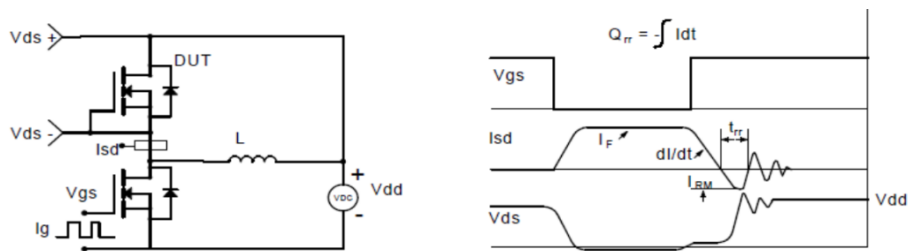

**Gate Charge Test Circuit and Waveform(N-Channel)**

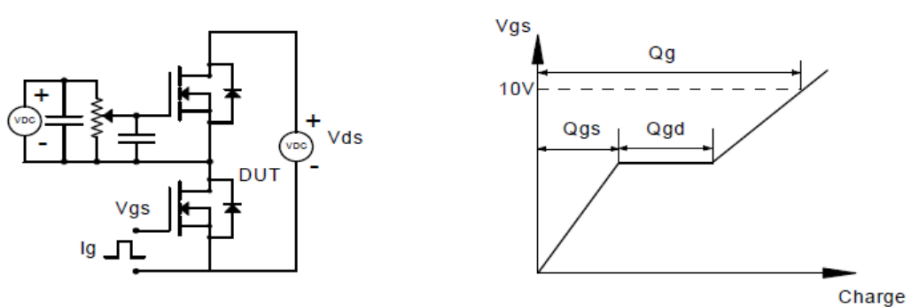

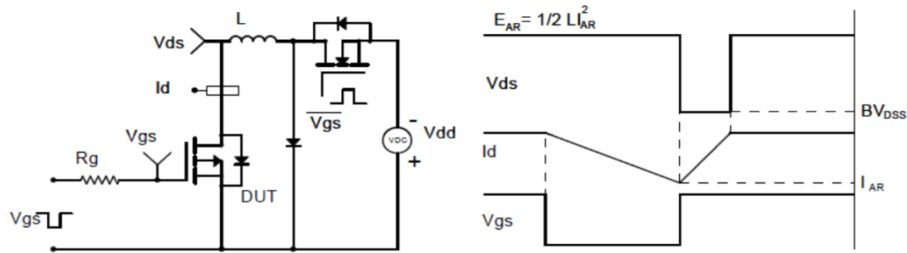
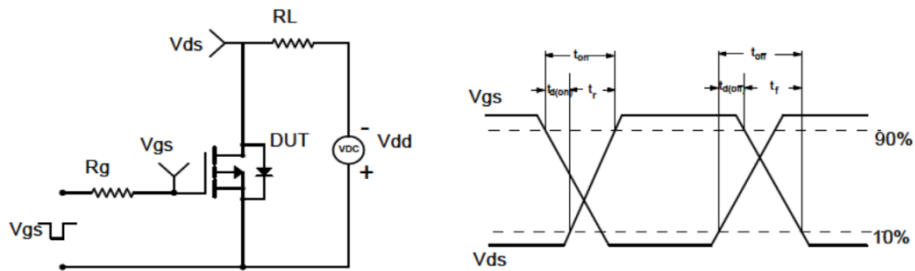
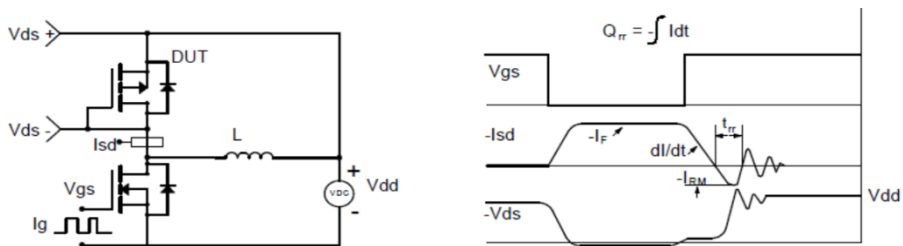
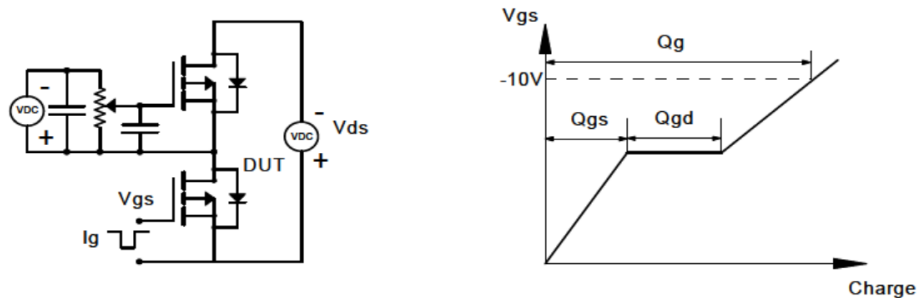
**Avalanche Test Circuit and Waveforms(P-Channel)**

**Switching Time Test Circuit and Waveforms(P-Channel)**

**Diode Recovery Test Circuit and Waveforms(P-Channel)**

**Gate Charge Test Circuit and Waveform(P-Channel)**

**Customer Service**

Kwansemi Semiconductor Co.,Ltd

Email:Sales@kwansemi.com

Web:www.kwansemi.com

**DISCLAIMER:**

Kwansemi reserves the right to change the specifications and circuitry without notice at any time. The Products are not designed for use in hostile environments, including, without limitation, aircraft, nuclear power generation, medical appliances, and devices or systems in which malfunction of any Product can reasonably be expected to result in a personal injury. Seller's customers using or selling Seller's products for use in such applications do so at their own risk and agree to fully defend and indemnify Seller.