

Features

- -30V/-18A,
 $R_{DS(ON)} = 11m\Omega(Typ.)@V_{GS}=-10V$
 $R_{DS(ON)} = 18m\Omega(Typ.)@V_{GS}=-4.5V$
- Low $R_{DS(ON)}$
- Super High Dense Cell Design
- Reliable and Rugged

Applications

- Load Switch
- PWM Applications
- Power Management



Halogen-Free

Pin Description

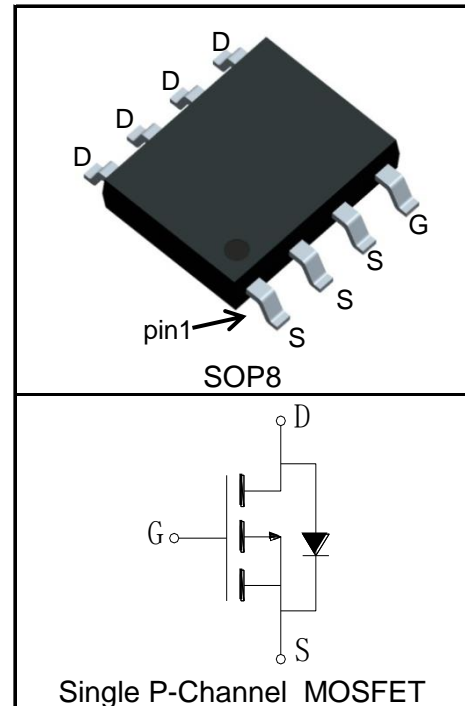

Absolute Maximum Ratings

Symbol	Parameter	Rating	Unit
Common Ratings ($T_A=25^\circ\text{C}$ Unless Otherwise Noted)			
V_{DSS}	Drain-Source Voltage	-30	V
V_{GSS}	Gate-Source Voltage	± 25	
T_J	Maximum Junction Temperature	150	$^\circ\text{C}$
T_{STG}	Storage Temperature Range	-55 to 150	$^\circ\text{C}$
I_S	Diode Continuous Forward Current	$T_A=25^\circ\text{C}$ -2.6	A
Mounted on Large Heat Sink			
$I_{DP}^{(1)}$	300 μs Pulse Drain Current Tested	$T_A=25^\circ\text{C}$ -72	A
$I_D^{(2)}$	Continuous Drain Current($V_{GS}=-10V$)	$T_A=25^\circ\text{C}$ -18	A
		$T_A=70^\circ\text{C}$ -14	
P_D	Maximum Power Dissipation	$T_A=25^\circ\text{C}$ 2.5	W
		$T_A=70^\circ\text{C}$ 1.6	
$R_{\theta JC}$	Thermal Resistance-Junction to Case	25	$^\circ\text{C/W}$
$R_{\theta JA}^{(3)}$	Thermal Resistance-Junction to Ambient	50	$^\circ\text{C/W}$
Drain-Source Avalanche Ratings			
$E_{AS}^{(4)}$	Avalanche Energy, Single Pulsed	TBD	mJ

Electrical Characteristics ($T_A=25^\circ\text{C}$ Unless Otherwise Noted)

Symbol	Parameter	Test Condition	KS3310HB			Unit
			Min.	Typ.	Max.	
Static Characteristics						
BV_{DSS}	Drain-Source Breakdown Voltage	$V_{GS}=0V, I_{DS}=-250\mu A$	-30			V
I_{DSS}	Zero Gate Voltage Drain Current	$V_{DS}=-30V, V_{GS}=0V$			-1	μA
		$T_J=125^\circ\text{C}$			-30	
$V_{GS(th)}$	Gate Threshold Voltage	$V_{DS}=V_{GS}, I_{DS}=-250\mu A$	-1.2	-1.6	-2.2	V
I_{GSS}	Gate Leakage Current	$V_{GS}=\pm 25V, V_{DS}=0V$			± 100	nA
$R_{DS(ON)}^{(5)}$	Drain-Source On-state Resistance	$V_{GS}=-10V, I_{DS}=-10A$		11	14	$m\Omega$
		$V_{GS}=-4.5V, I_{DS}=-6A$		18	23	$m\Omega$
Diode Characteristics						
$V_{SD}^{(5)}$	Diode Forward Voltage	$I_{SD}=-10A, V_{GS}=0V$		-0.8	-1.2	V
t_{rr}	Reverse Recovery Time	$I_{SD}=-10A, dI_{SD}/dt=-100A/\mu s$		18		ns
Q_{rr}	Reverse Recovery Charge			57		nC
Dynamic Characteristics⁽⁶⁾						
R_G	Gate Resistance	$V_{GS}=0V, V_{DS}=0V, F=1\text{MHz}$		2.6		Ω
C_{iss}	Input Capacitance	$V_{GS}=0V,$ $V_{DS}=-15V,$ Frequency=1.0MHz		2610		pF
C_{oss}	Output Capacitance			315		
C_{rss}	Reverse Transfer Capacitance			200		
$t_{d(ON)}$	Turn-on Delay Time	$V_{DD}=-15V, I_{DS}=-10A,$ $V_{GEN}=-10V, R_G=3\Omega$		15		ns
t_r	Turn-on Rise Time			21		
$t_{d(OFF)}$	Turn-off Delay Time			49		
t_f	Turn-off Fall Time			23		
Gate Charge Characteristics⁽⁶⁾						
Q_g	Total Gate Charge	$V_{DS}=-15V, V_{GS}=-10V,$ $I_{DS}=-10A$		40		nC
Q_{gs}	Gate-Source Charge			8		
Q_{gd}	Gate-Drain Charge			11		

- Notes:
- ① Pulse width limited by safe operating area.
 - ② Calculated continuous current based on maximum allowable junction temperature.
 - ③ When mounted on 1 inch square copper board, $t \leq 10\text{sec}$. The value in any given application depends on the user's specific board design.
 - ④ Limited by T_{Jmax} . Starting $T_J = 25^\circ\text{C}$.
 - ⑤ Pulse test; Pulse width $\leq 300\mu s$, duty cycle $\leq 2\%$.
 - ⑥ Guaranteed by design, not subject to production testing.

Ordering and Marking Information

Device	Package	Packaging	Quantity	Reel Size	Tape width
KS3310HB	SOP8	Tape&Reel	3000	13"	12mm

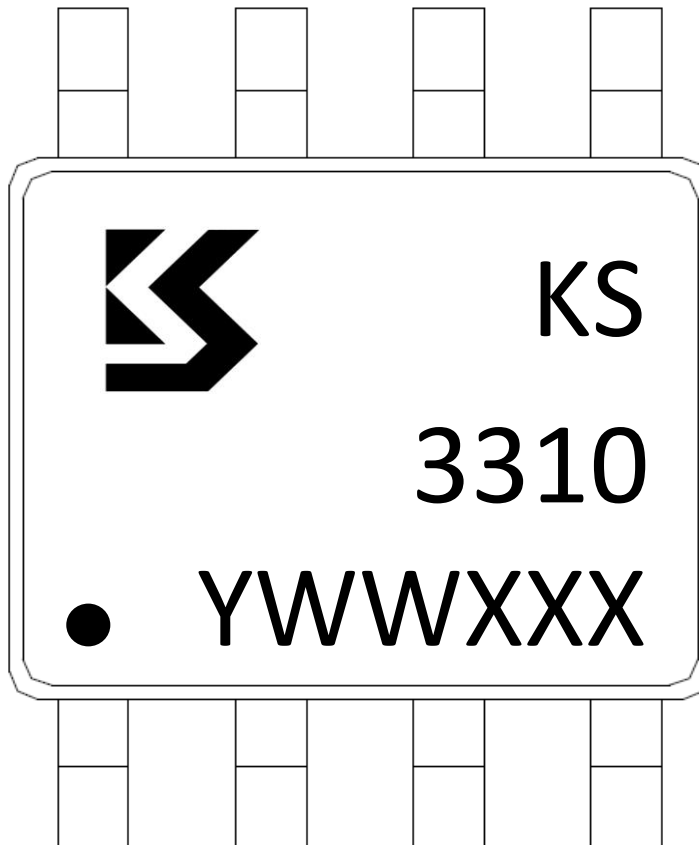

Y =Year,2017-A,2018-B,etc.

WW =Week.

XXX =Lot number.

Typical Characteristics

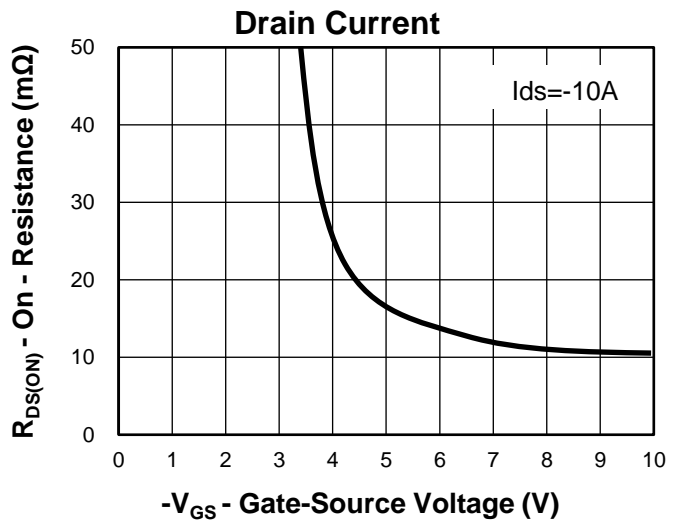
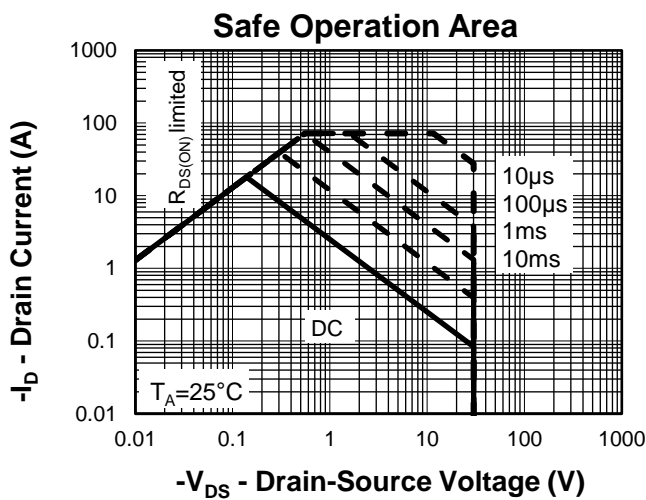
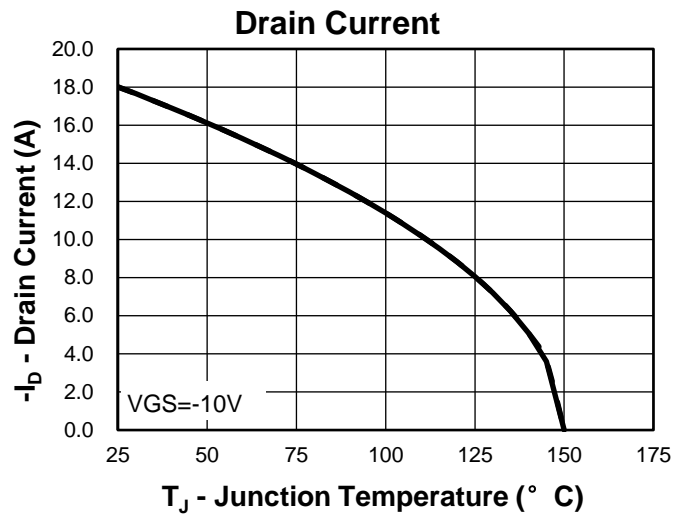
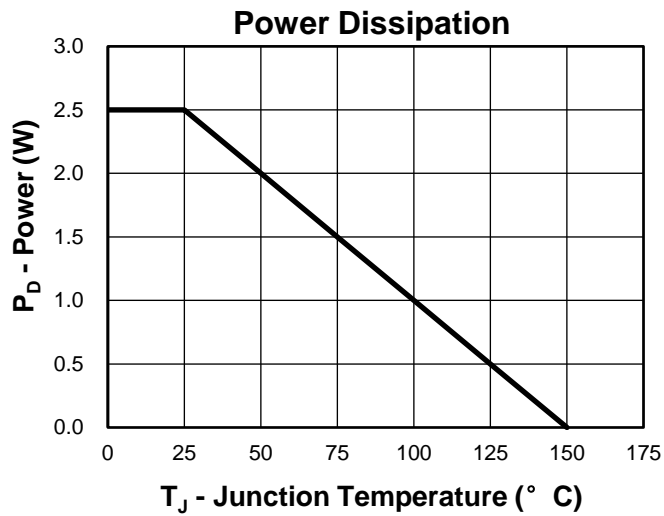

Thermal Transient Impedance

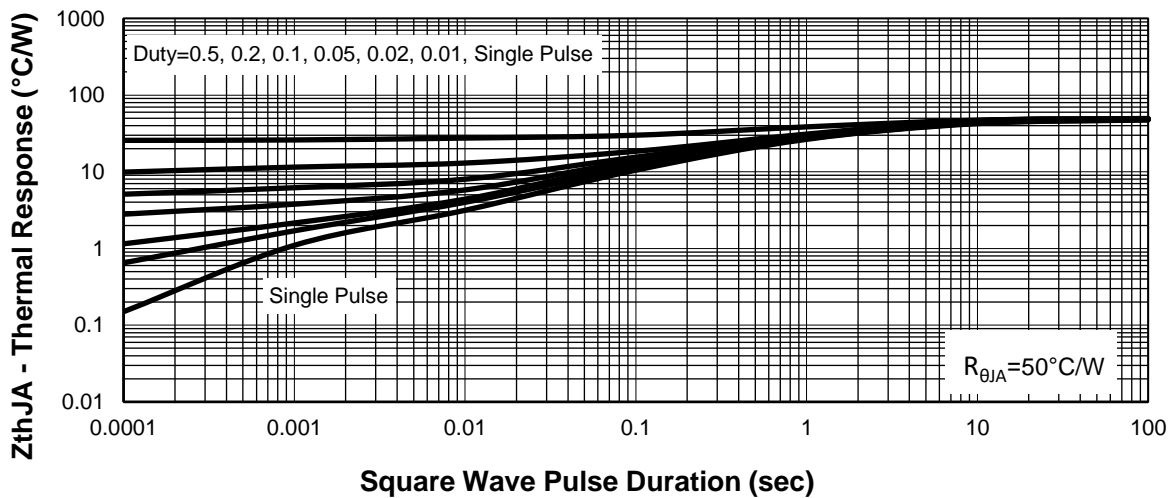

Typical Characteristics

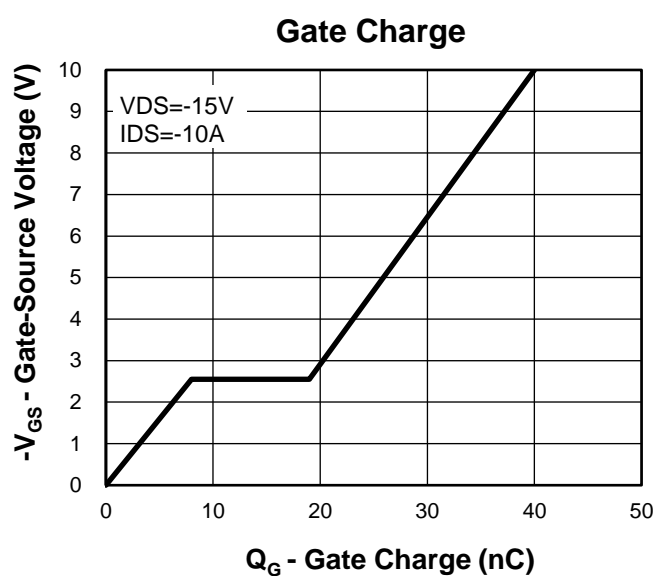
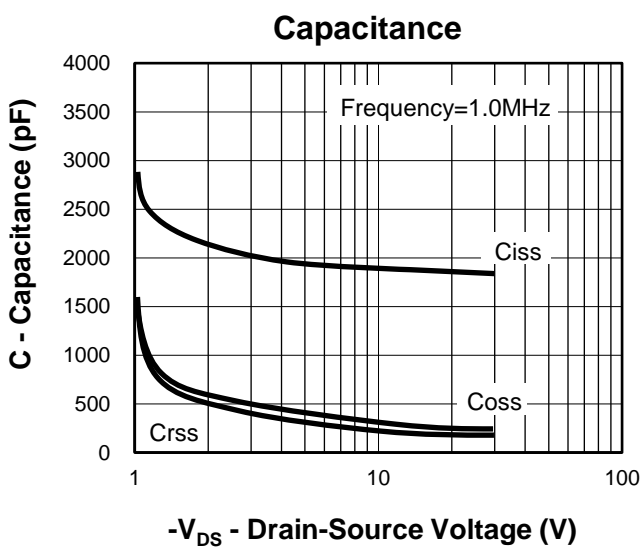
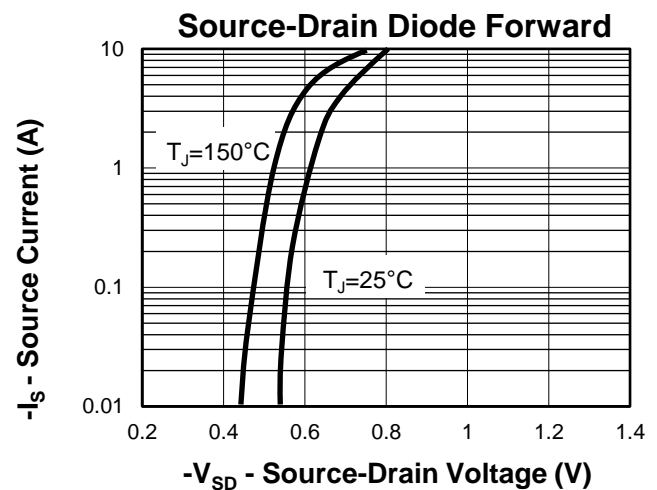
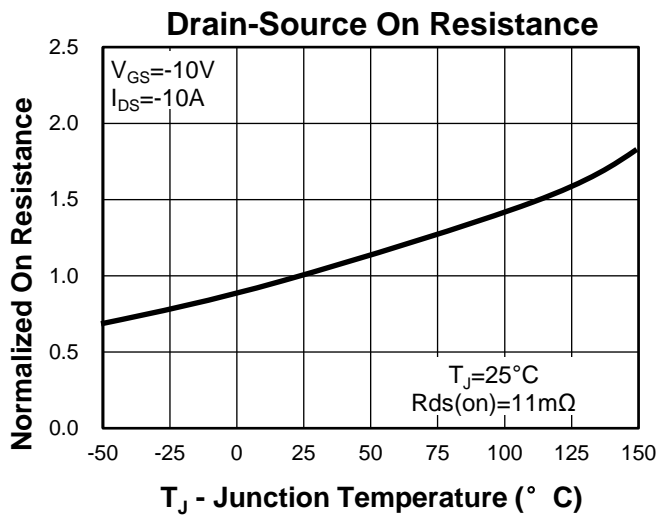
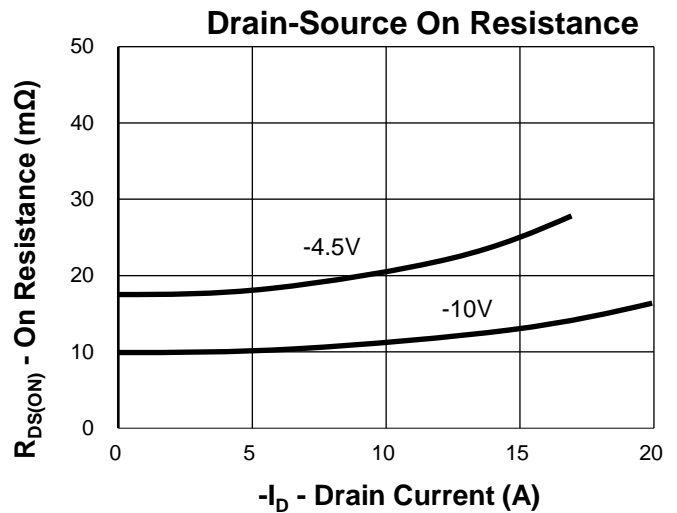
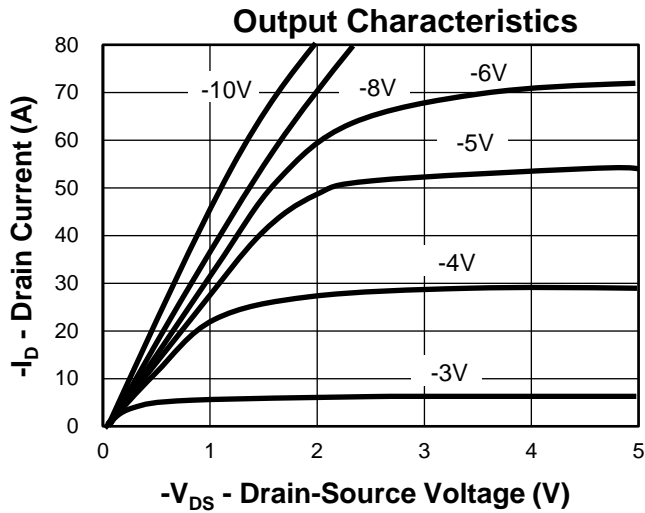

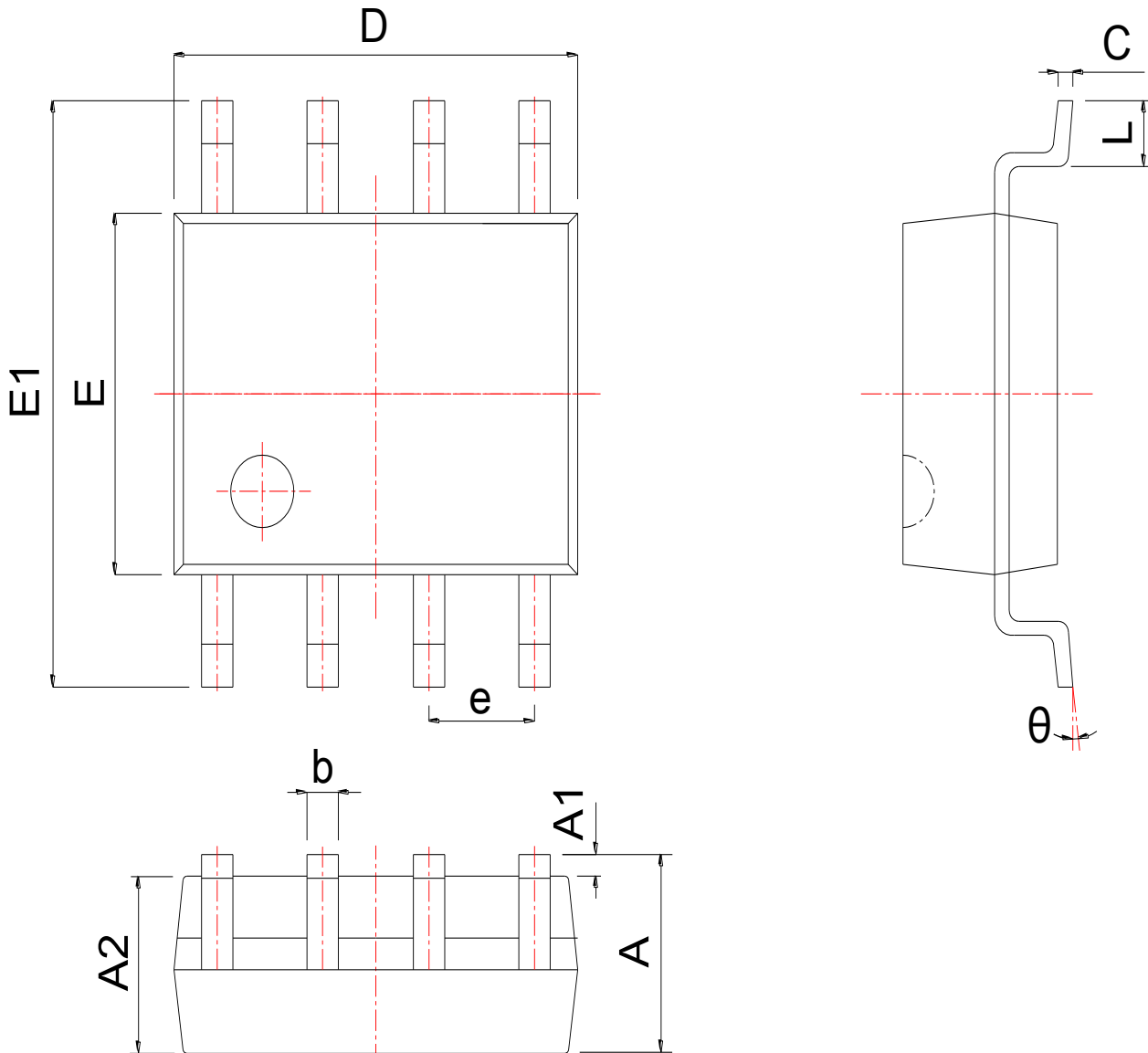
Package Information
SOP8

SYMBOL	MM			INCH		
	MIN	NOM	MAX	MIN	NOM	MAX
A	1.300	1.525	1.750	0.051	0.060	0.069
A1	0.050	0.150	0.250	0.002	0.006	0.010
A2	1.350	1.450	1.550	0.053	0.057	0.061
b	0.330	0.420	0.510	0.013	0.017	0.020
c	0.170	0.210	0.250	0.007	0.008	0.010
D	4.700	4.900	5.100	0.185	0.193	0.201
E	3.800	3.900	4.000	0.150	0.154	0.157
E1	5.800	6.000	6.200	0.228	0.236	0.244
e	1.270 BSC			0.050 BSC		
L	0.400	0.835	1.270	0.016	0.033	0.050
θ	0°		8°	0°		8°

Avalanche Test Circuit and Waveforms

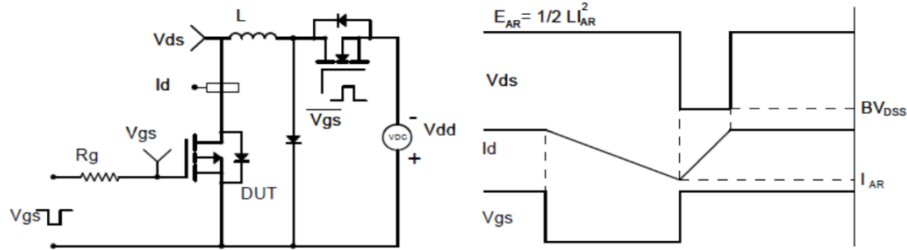

Switching Time Test Circuit and Waveforms

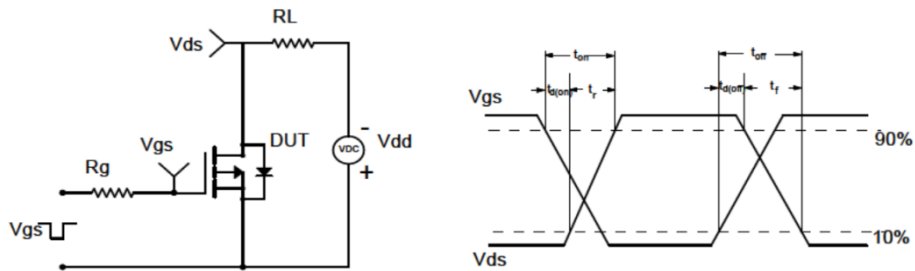

Diode Recovery Test Circuit and Waveforms

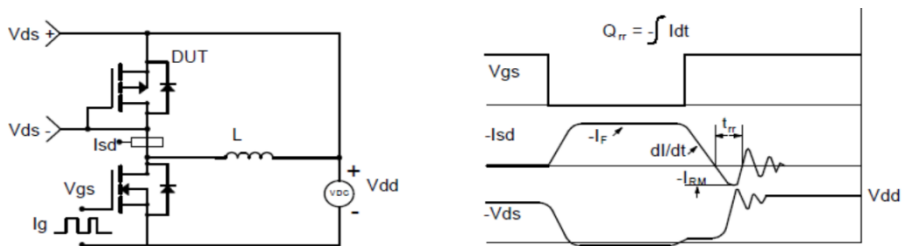

Gate Charge Test Circuit and Waveform

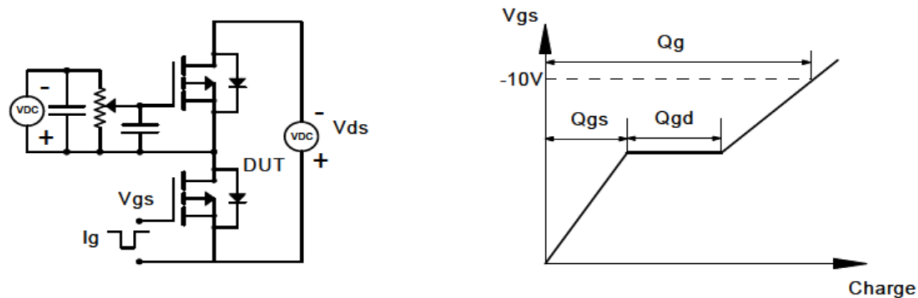

Customer Service

Kwansemi Semiconductor Co.,Ltd

Email:Sales@kwansemi.com

Web:www.kwansemi.com

DISCLAIMER:

Kwansemi reserves the right to change the specifications and circuitry without notice at any time. The Products are not designed for use in hostile environments, including, without limitation, aircraft, nuclear power generation, medical appliances, and devices or systems in which malfunction of any Product can reasonably be expected to result in a personal injury. Seller's customers using or selling Seller's products for use in such applications do so at their own risk and agree to fully defend and indemnify Seller.