

DIP8

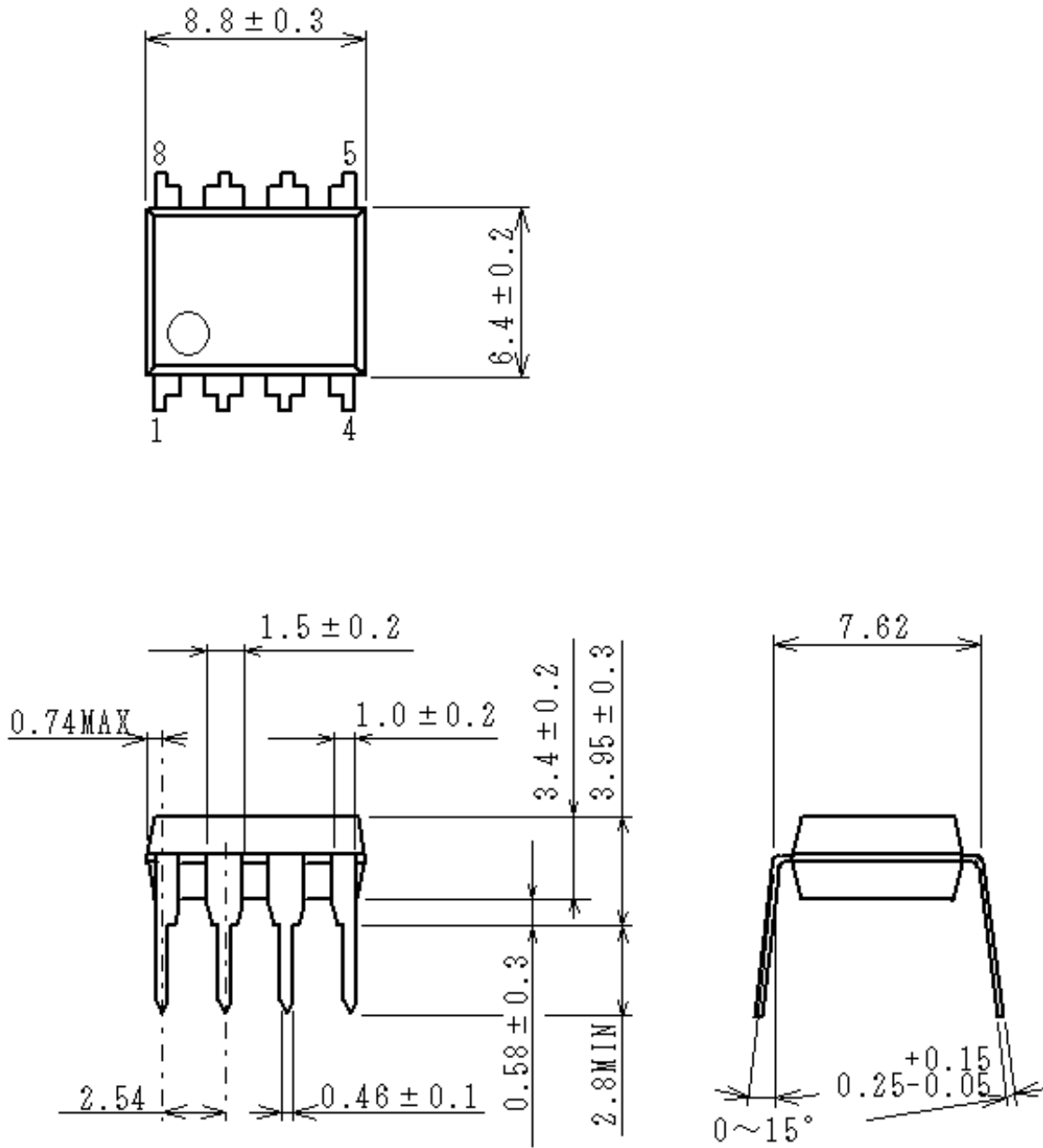

UNIT : mm